



ACO kupatilski program

Brošura



ACO ShowerDrain® E+

Telo i rešetka kanala od nerđajućeg čelika visokog kvaliteta elektropolirane površine visoke glatkoće.

Telo kanala garantovane vodonepropusnosti sa zavarenim izlivnim sifonom.

Fabrički montirana prirubnička vodonepropusna tkanina i otvori po obodu kanala za prihvat vode sa hidroizolacije.

Bočni izliv u pravcu kanala i slobodan pristup cevovodu. Podesive nožice za pozicioniranje i podešavanje visine ugradnje.

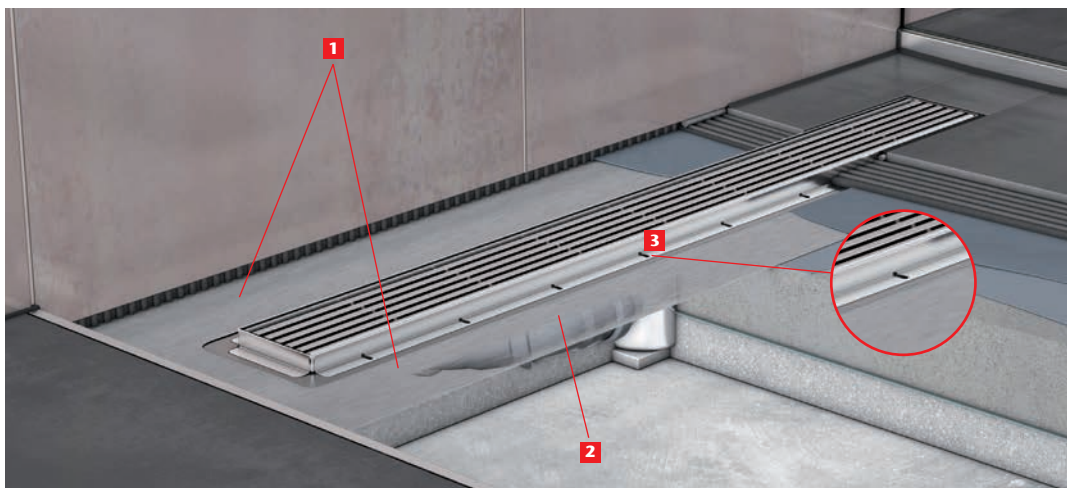

1. Prirubnica 2. Bočni izlivni priključak 3. Procedni otvori

Visina ugradnje za horizontalne i vertikalne zidne prirubnice

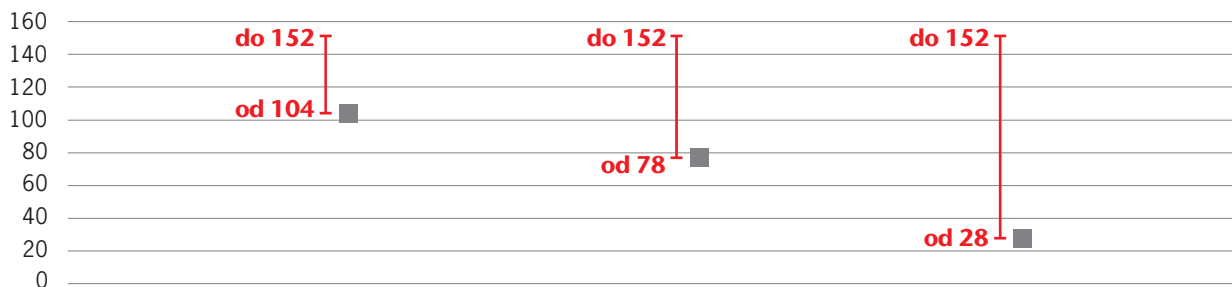

■ sa estrihom



ACO ShowerDrain® E+







Telo kanala - podaci za naručivanje



Proizvod	Tehnički crtež	Dimenzije			Broj artikla
		L1 (mm)	L2 (mm)	B (mm)	
Visina ugradnje: 104-152 mm (visina ruba kanala 12 mm)					
		600	700	187	9010.77.30
		700	800	187	9010.77.00
		800	900	187	9010.77.01
		900	1000	187	9010.77.02
		1000	1100	187	9010.77.03
		1200	1300	187	9010.77.04
		600	700	187	9010.77.31
		700	800	155	9010.77.05
		800	900	155	9010.77.06
		900	1000	155	9010.77.07
		1000	1100	155	9010.77.08
		1200	1300	155	9010.77.09
Visina ugradnje: 78-152 mm (visina ruba kanala 12 mm)					
		600	700	187	9010.77.32
		700	800	187	9010.77.10
		800	900	187	9010.77.11
		900	1000	187	9010.77.12
		1000	1100	187	9010.77.13
		1200	1300	187	9010.77.14
		600	700	187	9010.77.33
		700	800	155	9010.77.15
		800	900	155	9010.77.16
		900	1000	155	9010.77.17
		1000	1100	155	9010.77.18
		1200	1300	155	9010.77.19

Moguće je naručiti tuš kanal sa više izliva.

ACO ShowerDrain® E+

Rešetke - podaci za naručivanje

Izgled rešetke	Dužina (mm)	Broj artikla
	600	0155.05.98
	700	0153.73.42
	800	0153.73.43
	900	0153.73.44
	1000	0153.73.45
	1200	0153.73.46
	600	0155.06.00
	700	0153.73.59
	800	0153.73.60
	900	0153.73.61
	1000	0153.73.62
	1200	0153.73.63
	600	0155.06.02
	700	0153.73.69
	800	0153.73.70
	900	0153.73.71
	1000	0153.73.72
	1200	0153.73.73
	600	0155.06.08
	700	9010.56.03
	800	9010.56.04
	900	9010.56.05
	1000	9010.56.06
	1200	9010.56.07
	600	0155.06.12
	700	0153.81.87
	800	0153.81.88
	900	0153.81.89
	1000	0153.81.90
	1200	0153.81.91
	600	9010.72.18
	700	9010.72.12
	800	9010.72.13
	900	9010.72.14
	1000	9010.72.15
	1200	9010.72.16

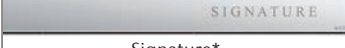
Izgled rešetke	Dužina (mm)	Broj artikla
	600	9010.79.15
	700	9010.76.82
	800	9010.76.83
	900	9010.76.84
	1000	9010.76.85
	1200	9010.76.86
	600	9010.79.16
	700	9010.78.82
	800	9010.78.83
	900	9010.78.84
	1000	9010.78.85
	1200	9010.78.86
		*Prema upitu

* Rešetka sa dva lica (Tile i Solid)



Akcesoari i rezervni delovi - podaci za naručivanje

Proizvod	Naziv	Opis	Kompatibilan sa	Broj artikla
	Mrežica E+	Mrežica za kosu smanjuje protok za 0,04 l/s Materijal: plastika	ShowersDrain E+	9010.72.00
	ACO EasyStop DN 40	Suvi sifon za ShowersDrain E+ i C Materijal: Plastika i guma	ShowersDrain E+ ShowersDrain C	9010.79.23
	ACO EasyStop DN 50	Suvi sifon za ShowersDrain E+ i ShowersDrain C Materijal: Plastika i guma	ShowersDrain E+ ShowersDrain C	9010.79.24



ACO ShowerDrain® S+

Iznenadjujuće jednostavno

Novi ACO ShowerDrain S+ kanal za odvodnjavanje tuš prostora sa svojim inovativnim dizajnom, donosi eleganciju i visoke performanse uz jednostavnu instalaciju i lako održavanje. Elegantni profil tuš kanalice napravljen je od elektropoliranog nerđajućeg čelika koji se savršeno uklapa sa bilo kojim tipom pločica u vašem kupatilu.

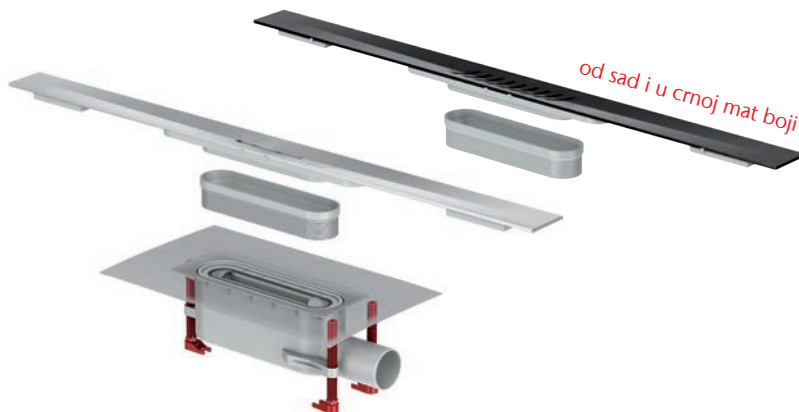
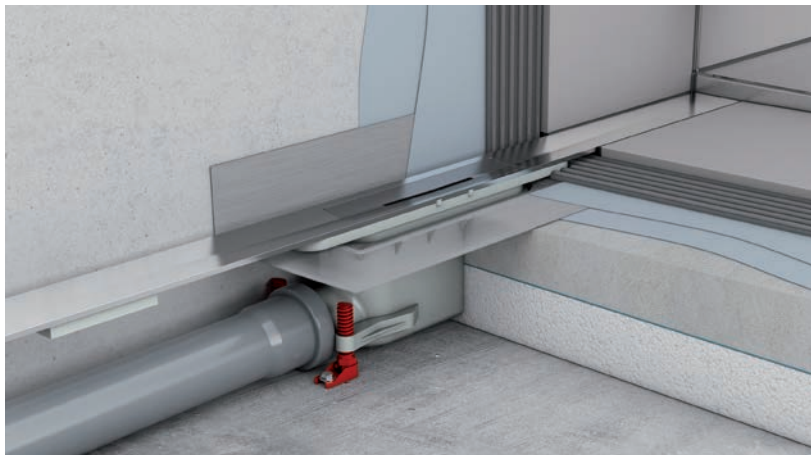

Prednosti:

- Montaža uz zid ili sa razmakom
- Fleksibilna dužina rešetke, moguće skraćivanje na gradilištu do 8 cm
- Jednostavno podešavanje visine
- Za debljinu završne obloge do 35 mm
- Fabrički integrisana prirubnica za spoj na hidroizolaciju
- Rešetka od nerđajućeg čelika AISI 304
- Izvadivi sifon s mogućnošću rastavljanja



Jednostavna instalacija



Jednostavno čišćenje



Funkcionalan dizajn

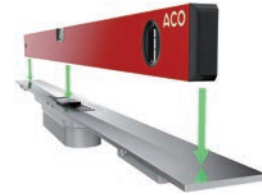

ACO ShowerDrain S+ Stripe

Proizvod	Tehnički crtež	Dimenzije			Broj artikla
		L1 (mm)	L2 (mm)	B (mm)	
		800	55	12	9010.51.01
		900	55	12	9010.51.02
		1000	55	12	9010.51.03
		1200	55	12	9010.51.04

ACO ShowerDrain S+ Plate

Proizvod	Tehnički crtež	Dimenzije			Broj artikla
		L1 (mm)	L2 (mm)	B (mm)	
		800	55	12	9010.51.11
		900	55	12	9010.51.12
		1000	55	12	9010.51.13
		1200	55	12	9010.51.14

Proizvod	Tehnički crtež	Prečnik izliva sifona	Nagib	Visina ugradnje sifona bez rešetke	Visina vodenog stuba sifona	Broj artikla
		DN 50	1,5°	90-180 mm	50 mm	9010.51.20
		DN 50	1,5°	70-160 mm	30 mm	9010.51.21

Atestirano na nosivost invalidskih kolica

ACO ShowerDrain® C

ACO ShowerDrain® C kanal za tuš kabine sadrži visoko kvalitetan kanal i rešetku od nerđajućeg čelika kvaliteta AISI 304. Svi delovi su izuzetne završne obrade i odgovaraju svim higijenskim zahtevima.

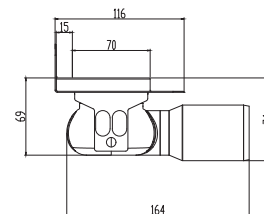
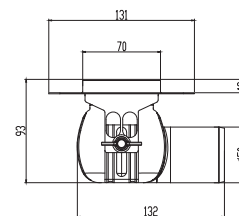
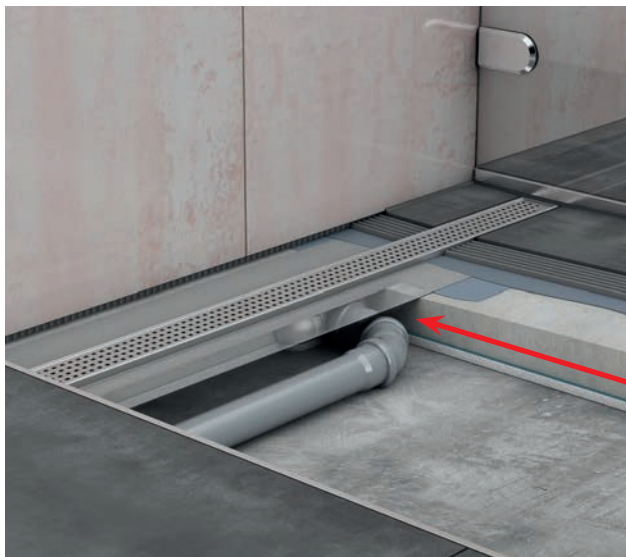

Telo kanala sa horizontalnom flanšom - podaci za naručivanje

Proizvod	Tehnički crtež	Dimenzije			Broj artikla
		L1 (mm)	L2 (mm)	B (mm)	
Ugradbena visina H = 74 mm za sifon visine (SV) 25 mm, visina ruba kanala 12 mm					
		585	645	131	9010.88.21
		685	745	131	9010.88.22
		785	845	131	9010.88.23
		885	945	131	9010.88.24
		985	1045	131	9010.88.25
		1185	1245	131	9010.88.27
Ugradbena visina H = 93 mm za sifon visine (SV) 50 mm, visina ruba kanala 12 mm					
		585	645	131	9010.88.00
		685	745	131	9010.88.01
		785	845	131	9010.88.02
		885	945	131	9010.88.03
		985	1045	131	9010.88.04
		1185	1245	131	9010.88.06



Telo kanala sa vertikalnom flanšom - podaci za naručivanje

Proizvod	Tehnički crtež	Dimenzije			Broj artikla
		L1 (mm)	L2 (mm)	B (mm)	
Ugradbena visina H = 74 mm za sifon visine (SV) 25 mm, visina ruba kanala 12 mm					
		585	645	116	9010.88.28
		685	745	116	9010.88.29
		785	845	116	9010.88.30
		885	945	116	9010.88.31
		985	1045	116	9010.88.32
		1185	1245	116	9010.88.34
Ugradbena visina H = 93 mm za sifon visine (SV) 50 mm, visina ruba kanala 12 mm					
		585	645	116	9010.88.07
		685	745	116	9010.88.08
		785	845	116	9010.88.09
		885	945	116	9010.88.10
		985	1045	116	9010.88.11
		1185	1245	116	9010.88.13

Rešetke - podaci za naručivanje

Izgled rešetke	Dužina (mm)	Broj artikla	Izgled rešetke	Dužina (mm)	Broj artikla
 Wave	585	9010.88.60	 Tile	585	9010.88.81
	685	9010.88.61		685	9010.88.82
	785	9010.88.62		785	9010.88.83
	885	9010.88.63		885	9010.88.84
	985	9010.88.64		985	9010.88.85
	1185	9010.88.66		1185	9010.88.87
 Quadrato	585	9010.88.67	 Massive	585	9010.88.88
	685	9010.88.68		685	9010.88.89
	785	9010.88.69		785	9010.88.90
	885	9010.88.70		885	9010.88.91
	985	9010.88.71		985	9010.88.92
	1185	9010.88.73		1185	9010.88.94

SPECIJALNA PONUDA Telo kanala sa vertikalnom flanšom i WAVE rešetkom - podaci za naručivanje

Proizvod	Tehnički crtež	Dimenzije			Broj artikla
		L1 (mm)	L2 (mm)	B (mm)	
Ugradbena visina H = 74 mm za sifon visine (SV) 25 mm, visina ruba 12 mm					
		585	645	116	9010.88.42
		685	745	116	9010.88.43
		785	845	116	9010.88.44
		885	945	116	9010.88.45

Aksesoari i rezervni delovi - podaci za naručivanje

Proizvod	Naziv	Opis	Kompatibilan sa	Broj artikla
	Mrežica C	Mrežica za kosu Materijal: plastika	ShowerDrain C	9010.88.59
	ACO EasyStop DN 40	Suvi sifon za ShowerDrain E+ i C Materijal: Plastika i guma	ShowerDrain E+ ShowerDrain C	9010.79.23
	ACO EasyStop DN 50	Suvi sifon za ShowerDrain E+ i ShowerDrain C Materijal: Plastika i guma	ShowerDrain E+ ShowerDrain C	9010.79.24



ACO ShowerDrain[®] C - Blackline

Kako bi sledili trendove moderno dizajniranih kupatila i walk-in tuš prostora, ACO ShowerDrain C kanalica za kupatilo, sa mat crnim završnim premazom, pretvorena je u dodatni dekorativni element u Vašem kupatilu, ACO ShowerDrain Blackline.

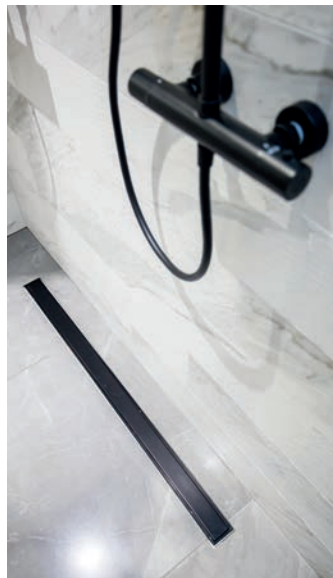

Karakteristike:

- Ugradbena visina 74 mm sa horizontalnim izlivom DN 50
- Komplet: Kanal i Solid rešetka za kupatilo
- Materijal: nerđajući čelik
- Boja: crna mat
- Horizontalna priрубnica
- Odvojivi sifon za optimalno čišćenje



Proizvod	Tehnički crtež	Dimenzije			Broj artikla
		L1 (mm)	L2 (mm)	B (mm)	
		585	645	130	9010.91.07
		685	745	130	9010.91.08
		785	845	130	9010.91.09
		885	945	130	9010.91.10
		985	1045	130	9010.91.11
		1085	1145	130	9010.91.12
		1185	1245	130	9010.91.13

ACO ShowerStep

ACO ShowerStep za elegantan prelaz između tuš kabine i ostatka prostora u kupatilu.



Profilisani element od nerđajućeg čelika koji značajno olakšava ugradnju pločica i estetski prelaz između dva različita nivoa u kupatilu. ACO ShowerStep krajnjem korisniku obezbeđuje dugoročno rešenje sa jednostavnim održavanjem.

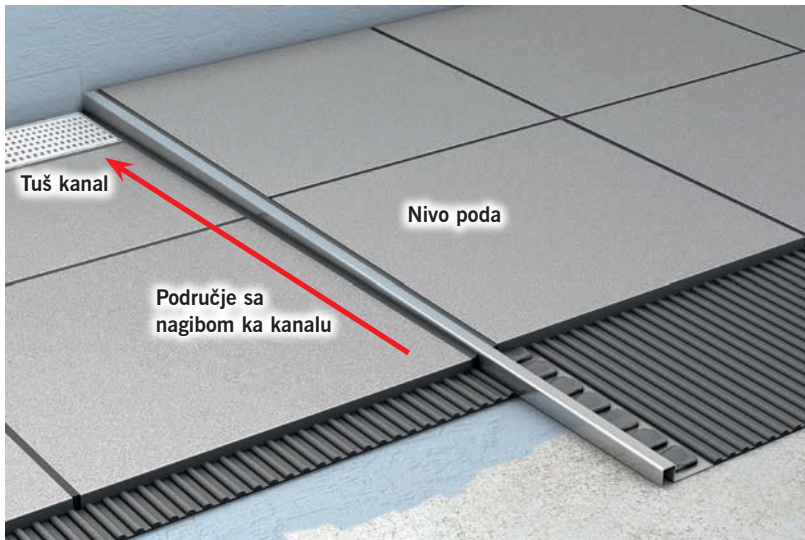

Prednosti:

- Tri različite visine (10, 12,5 i 15 mm) za različite debljine pločica
- Dve raspoložive dužine (990 i 1490 mm)
- Jednostavan za ugradnju
- Profil je širine 12 mm tako da omogućava postavljanje staklenih pregrada na samom profilu
- Rešava problematiku prelaza između dva nivoa keramike i tranzicije prostora
- Ugrađen pad u profilu
- Nerđajući čelik (kvalitet AISI 304)

Obrada površina

- Četkana površina za proizvodni program ACO ShowerDrain® C
- Elektropolirana površina za proizvodni program ACO ShowerDrain® E+ i S+



ACO ShowerStep Black

ACO ShowerStep - podaci za naručivanje

Mesto ugradnje	Dužina L (mm)	Visina H1 (mm)	Visina H2 (mm)		Broj artikla		Broj artikla
levo	1490	10	36	Element za ACO ShowerDrain® C	9010.72.41	Element za ACO ShowerDrain® S+ i E+	9010.72.53
	1490	12,5			9010.72.42		9010.72.54
	1490	15			9010.72.43		9010.72.55
	990	10	9010.72.44		9010.72.56		
	990	12,5	9010.72.45		9010.72.57		
	990	15	9010.72.46		9010.72.58		
desno	1490	10	36		9010.72.47		9010.72.59
	1490	12,5			9010.72.48		9010.72.60
	1490	15			9010.72.49		9010.72.61
	990	10	9010.72.50		9010.72.62		
	990	12,5	9010.72.51		9010.72.63		
	990	15	9010.72.52		9010.72.64		

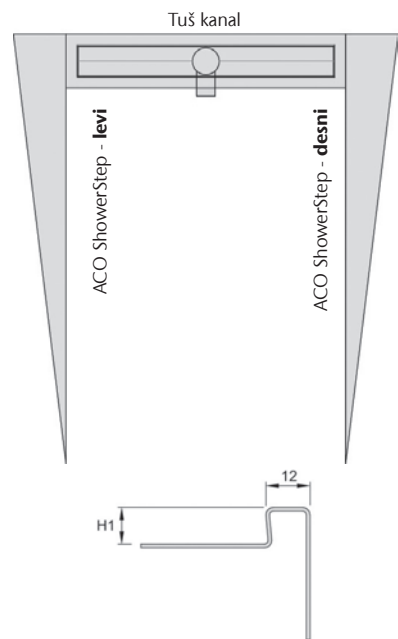
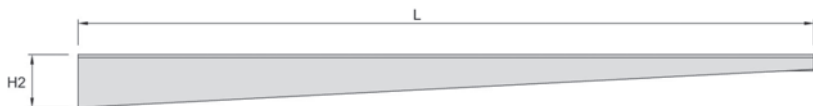

ACO ShowerStep Black - podaci za naručivanje

Mesto ugradnje	Dužina L (mm)	Visina H1 (mm)	Broj artikla
Levo	1490	10	9010.91.42
	1490	12.5	9010.86.38
	1490	15	9010.91.44
	990	10	9010.91.45
	990	12.5	9010.91.46
	990	15	9010.91.47
Desno	1490	10	9010.91.48
	1490	12.5	9010.86.39
	1490	15	9010.91.50
	990	10	9010.91.51
	990	12.5	9010.91.52
	990	15	9010.91.53

ACO EasyFlow[®] plastični podni slivnici



Tile rešetka







Rešetka sa zaključavanjem







Kružna rešetka

ACO Dizajn rešetke za EasyFlow® plastične podne slivnike

ACO Dizajn rešetke od nerđajućeg čelika za gornje delove slivnika sa rubom od nerđajućeg čelika, kvadratnog i kružnog oblika. Debljina rešetke je 5,5 mm.

Kvadratni oblik					
Izgled rešetke					
	Quadrato	Wave	Forest	Hawaii	Mix
Dim. rešetke (mm)	140x140	140x140	140x140	140x140	140x140
Dim. rama (mm)	149x149	149x149	149x149	149x149	149x149
Broj artikla	5141.08.22	5141.08.28	5141.20.26	5141.20.29	5141.20.30

Kružni oblik					
Izgled rešetke					
	Quadrato	Wave	Forest	Hawaii	Mix
Dim. rešetke (mm)	126	126	126	126	126
Dim. rama (mm)	136	136	136	136	136
Broj artikla	5141.25.22	5141.25.28	5141.25.26	5141.25.29	5141.25.30



ACO EasyFlow plastični gornji deo slivnika sa rubom i rešetkom od nerđajućeg čelika, bez zaključavanja, dim. 149x149 mm.

Građevinska visina 18-135 mm.







Br. Artikla **5141.22.00**

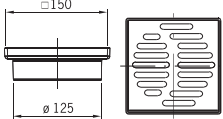

ACO EasyFlow[®] plastični podni slivnici

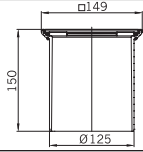
ACO EasyFlow[®] gornji delovi od ABS plastike podesive visine

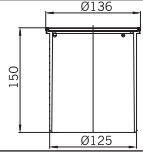
Gornji delovi - podaci za naručivanje

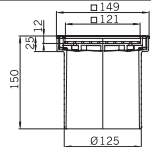
Proizvod	Tehnički crtež	Opis proizvoda	Broj artikla
		Okvir od plastike 150x150 mm rešetka od nerđ. čel. 142,5x142,5 mm klasa opterećenja K3 visinski podesiv od 15-96 mm	2700.77.11
		Gornji deo za dizajn rešetke, slobodne i rešetke sa zaključavanjem Mogućnost podešavanja visine od 20-135 mm u kombinaciji sa telom slivnika EasyFlow	5141.43.00
		Gornji deo za dizajn kružne rešetke Mogućnost podešavanja visine od 8-135 mm u kombinaciji sa telom slivnika EasyFlow	5141.46.00
		Gornji deo za ispunu keramičkim pločicama, TILE Mogućnost podešavanja visine od 26-135 mm u kombinaciji sa telom slivnika EasyFlow, sloj za ispunu 10 mm	5141.24.00

Dodatni pribor za sve tipove slivnika

<p>Flanša za spajanje hidroizolacije uklještenjem</p> <p>Materijal: Plastika/Nerđajući čelik</p> <p>Art.Broj: 2040.00.02</p> 	<p>Flanša za plitku ugradnju</p> <p>Materijal: Plastika</p> <p>Vodoneprop. tkanina</p> <p>Art.Broj: 2040.00.01</p> 	<p>Flanša za spajanje hidroizolacije bez uklještenja</p> <p>Materijal: Plastika</p> <p>Art.Broj: 0173.09.13</p> 
--	--	---





ACO EasyFlow® plastični podni slivnici

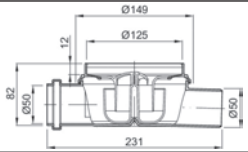

ACO EasyFlow® plastični podni slivnici, sa sifonom, visinski podesivi, sa bočnim ulivom, flanšom i rešetkom od nerđajućeg čelika sa protiv-isparavajućom membranom.

ACO EasyFlow® kupatilski slivnici se mogu kombinovati zavisno od individualnih želja, sa različitim nasadnim elementima okruglog ili kvadratnog oblika - opciono sa ili bez prirubnice za postavljanje plitke hidroizolacije.

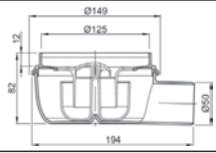
Telo slivnika DN50, HORIZONTALNI IZLIV - podaci za naručivanje

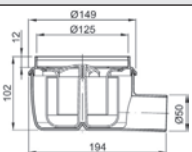



Proizvod	Tehnički crtež	Opis proizvoda	Broj artikla
Telo protočnog slivnika DN50, h=82 mm			
		Telo protočnog slivnika DN 50 FlatLine hor. izliv 1,5° sa demontažnim suvim sifonom visina vodenog stuba u sifonu 30 mm bočni uliv DN50 sa čepom; protok: 1,0 l/sec.	2505.00.15
Telo slivnika DN50, h=82 mm			
		Telo slivnika DN 50 FlatLine horizontalni izliv 1,5° sa demontažnim suvim sifonom visina vodenog stuba u sifonu 30 mm protok: 1,0 l/sec.	2505.05.15
Telo slivnika DN50, h=102 mm			
		Telo slivnika DN 50 horizontalni izliv 1,5° sa demontažnim suvim sifonom visina vodenog stuba u sifonu 50 mm protok: 1,6 l/sec.	2500.05.15

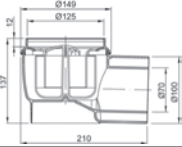

Telo slivnika DN70/100, HORIZONTALNI IZLIV - podaci za naručivanje

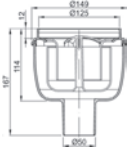
Proizvod	Tehnički crtež	Opis proizvoda	Broj artikla
Telo slivnika DN70/100, h=137 mm			
		Telo slivnika DN 70/100 horizontalni izliv 1,5° sa demontažnim suvim sifonom visina vodenog stuba u sifonu 50 mm; protok: 1,8 l/sec.	2700.05.15

Telo slivnika DN50, DN70 i DN100, VERTIKALNI IZLIV - podaci za naručivanje

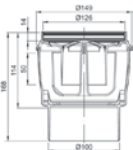

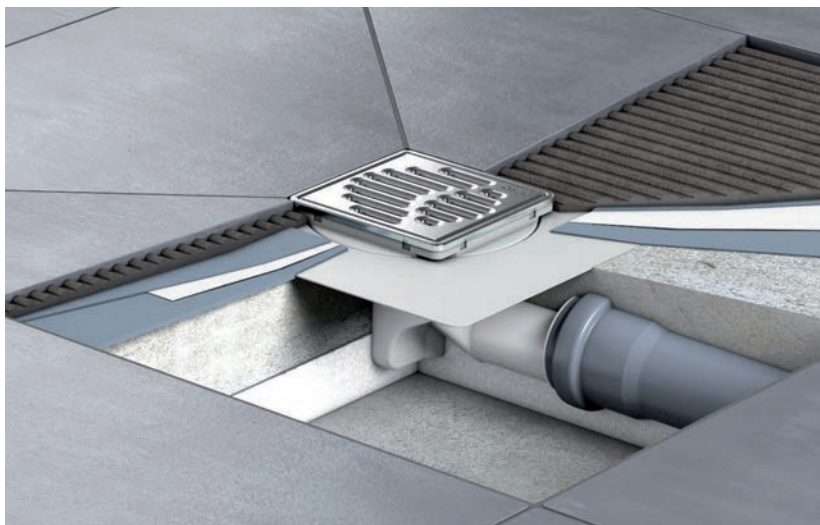

Proizvod	Tehnički crtež	Opis proizvoda	Broj artikla
Telo slivnika DN50, h=167 mm			
		Telo slivnika DN 50 vertikalni izliv 90° sa demontažnim suvim sifonom visina vodenog stuba u sifonu 50 mm; protok: 1,6 l/sec.	2500.55.15
Telo slivnika DN70, h=168 mm			
		Telo slivnika DN 70 vertikalni izliv 90° sa demontažnim suvim sifonom visina vodenog stuba u sifonu 50 mm; protok: 1,8 l/sec.	2710.00.15
Telo slivnika DN100, h=168 mm			
		Telo slivnika DN 100 vertikalni izliv 90° sa demontažnim suvim sifonom visina vodenog stuba u sifonu 50 mm; protok: 2,0 l/sec.	2810.00.15

ACO kupatilski MG slivnici

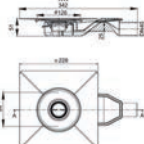

Prednosti proizvoda

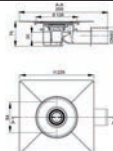
- Ispunjava zahteve SRPS EN 1253-1
- Rešetka i ram od nerđajućeg čelika, a telo kanala od polipropilena
- Minimalna visina ugradnje
- Uključuje flanšu za vezu sa hidroizolacijom premazivanjem
- 50 mm po obimu
- Hrapava
- Slobodan pristup cevovodu
- Izvadivi sifonski uložak
- Kompletan sistem

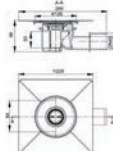
Proizvod	Tehnički crtež	Opis proizvoda	Broj artikla
Najplići MG slivnik, horizontalni izliv			
		Izliv DN40, protok 0,5l/s Visina vodenog stuba u sifonu 25mm Minimalna visina ugradnje 52mm	2245.25.00
MG slivnik, horizontalni izliv			
		Izliv DN40 i DN50, protok 0,5l/s Visina vodenog stuba u sifonu 30mm Minimalna visina ugradnje 76mm	2245.30.00
MG slivnik, horizontalni izliv			
		Horizontalni izliv DN40 i DN50, protok 0,5l/s Visina vodenog stuba u sifonu 50mm Minimalna visina ugradnje 96mm	2245.50.00

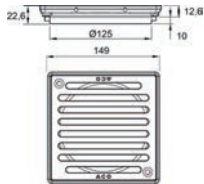

Proizvod	Tehnički crtež	Opis proizvoda	Broj artikla
MG slivnik, vertikalni izliv			
		Vertikalni izliv DN50, protok 0,5l/s Visina vodenog stuba u sifonu 50mm	2259.50.00
Rebrasta rešetka 10x10cm, debljine 2mm			
		Od nerđajućeg čelika, veličina 100x100mm, za keramiku debljine 6mm	9010.68.06
Prečkasta rešetka 15x15cm, debljine 4mm			
		Od nerđajućeg čelika, veličina 150x150mm, za keramiku debljine 6mm ili za deblju uz dodatni prsten za povišenje	9010.68.07
Rešetka za ispunu pločicom			
		Četvrtastog oblika od plastike sa rubom od nerđajućeg čelika, veličina 149x149mm, visina 26mm	620477

Atestirano na nosivost invalidskih kolica



ACO. we care for water



ACO građevinski elementi d.o.o.

III Industrijska zona bb

22314 Krnješevci, Stara Pazova

Tel: +381 22 811 580

E-mail: aco@aco.rs

www.aco.rs

ACO-09/22 - Zadržavamo pravo izmena