



**kolpa·san**

**2 0 2 6**

slovenski english hrvatski srpski

# INDEX

<b>Info</b> Info Info Info	<u>002</u>
<b>Unique by Kolpasan</b> Unique by Kolpasan Unique by Kolpasan Unique by Kolpasan	<u>018</u>
<b>Masažne in kopalne kadi</b> Massage and bathtubs Masažne i kupaonske kade Masažne i kade za kupanje	<u>020</u>
<b>Masažni stebri, tuš stebri</b> Massage massage columns, shower columns Masažni stupovi, tuš stupovi Masažni stubovi, stubovi za tuširanje	<u>036</u>
<b>Tuš kadi</b> Shower trays Tuš kade Tuš kade	<u>044</u>
<b>Tuš kabine</b> Shower enclosures Tuš kabine Tuš kabine	<u>062</u>
<b>Kopalniško pohištvo</b> Bathroom furniture Kupaonski namještaj Nameštaj za kupatilo	<u>102</u>
<b>Kopalniški dodatki</b> Bathroom accessories Kupaonski dodaci Kupatilski dodaci	<u>136</u>



**Predstavitev podjetja**  
About us  
Predstavljanje poduzeća  
Predstavljanje preduzeća

002

## Kolpa

- Vodilni proizvajalec kopalniške opreme v srednji in jugovzhodni Evropi.
- **48** letna tradicija v sanitarni branži.
- Lasten dizajn, razvoj in proizvodnja programa kompozitnih materialov Kerrock.
- Izvozno naravnana družba, ki **80%** proizvodov izvozi na zahtevne evropske trge.
- Z našimi izdelki in podružnicami smo prisotni v **45**-ih državah.
- Skupaj imamo **100.000 m<sup>2</sup>** proizvodnih in skladiščnih površin.

## Kolpa

- Leading manufacturer of bathroom products in Central and Southeastern Europe.
- **48** years of tradition.
- In-house design, development and production of Kerrock composite materials.
- Export oriented, with **80%** of products exported to the demanding European markets.
- Our products and offices are present in **45** countries.
- We have a total of **100,000 m<sup>2</sup>** of production and warehouse areas.

## Kolpa

- Vodeći proizvođač opreme za kupaonice u srednjoj i jugoistočnoj Europi.
- **48** godina tradicije u sanitarnoj branši.
- Vlastiti dizajn, razvoj i proizvodnja programa kompozitnih materijala Kerrock.
- Izvozno orijentirana tvrtka koja **80%** proizvoda izvozi na zahtjevna europska tržišta.
- S našim proizvodima i podružnicama prisutni smo u **45** države.
- Ukupno imamo **100.000 m<sup>2</sup>** proizvodnih i skladišnih površina.

## Kolpa

- Vodeći proizvođač opreme za kupatila u srednjoj i jugoistočnoj Evropi.
- **48** godina iskustva u sanitarnoj branši.
- Vlastiti dizajn, razvoj i proizvodnja programa kompozitnih materijala Kerrock.
- Izvozno orijentisana firma koja **80%** proizvoda izvozi na zahtevna evropska tržišta.
- Sa našim proizvodima i podružnicama prisutni smo u **45** države.
- Ukupno imamo **100.000 m<sup>2</sup>** proizvodnih i skladišnih površina.







**Trajnost**  
Durability  
Održivost  
Održivost

004

## Trajnost

„Podpisani z okoljskim certifikatom ISO 14001 stalno iščemo nove možnosti uporabe trajnostnih surovin. Zavedamo se namreč pomembne vloge na področju družbene odgovornosti. Do narave, lokalnega okolja in širše družbe. Zavezani prihodnjim generacijam želimo tako z inovativnimi izdelki in rešitvami ustvarjati največji odtis kakovosti in po drugi strani najmanjšega do okolja.“

Generalni direktor Borut Šterbenc

## Durability

“Signed with ISO 14001 environmental certification, we are constantly looking for new ways to use sustainable raw materials. We are aware that we are playing an important role in corporate social responsibility. For nature, the local environment and wider society. Committed to future generations and with innovative products and solutions, we want to create the biggest footprint of quality and the smallest footprint for the environment.”

Director General Borut Šterbenc



**Trajnost**  
Durability  
Održivost  
Održivost

# 95%

**odpadkov uspešno recikliramo.**

95% of waste is successfully recycled.

Uspješno recikliramo 95 % otpada.

95% otpada uspešno recikliramo.

# 1/3

**pridobivanje lastne zelene energije.**

1/3 of energy is our own green energy.

Proizvodimo 1/3 vlastite zelene energije.

Generisanje 1/3 sopstvene zelene energije.

# -65%

**zmanjšana poraba pitne vode.**

65 % reduction in drinking water consumption.

Trošimo 65 % manje pitke vode.

65 % smanjena potrošnja pijaće vode.

## Održivost

„Uz certifikat upravljanja okolišem ISO 14001, neprestano tražimo nove načine upotrebe održivih sirovina. Svjesni smo, naime, važne uloge u području društvene odgovornosti. Prema prirodi, lokalnoj sredini i širem društvu. Stoga, posvećeni budućim generacijama, inovativnim proizvodima i rješenjima želimo stvoriti najveći otisak kvalitete, a s druge strane najmanji utjecaj na okoliš.“

Generalni direktor Borut Šterbenc

## Održivost

„Kao nosioci ekološkog sertifikata ISO 14001, stalno tražimo nove mogućnosti upotrebe održivih sirovina. Naime, svesni smo značajne uloge u oblasti društvene odgovornosti. Prema prirodi, lokalnoj životnoj sredini i širem društvu. Obavezani prema budućim generacijama, pomoću inovativnih proizvoda tako želimo da stvorimo najveći odraz kvaliteta, a sa druge strane, najmanji uticaj na životnu sredinu.“

Generalni direktor Borut Šterbenc



## Razstavni salon kolpa

Kolpa Showroom  
Izložbeni salon Kolpa  
Izložbeni salon Kolpa

006





## Razstavni salon kolpa

Kolpa Showroom  
Izložbeni salon Kolpa  
Izložbeni salon Kolpa

007

## PE Razstavno prodajni salon Kolpa - Metlika

Cesta XV. brigade 49, 8330 Metlika



- **940** eksponatov
- **120** ambientov
- **3.378** m<sup>2</sup> razstavnih površin
- **940** items
- **120** showroom ideas
- **3378** m<sup>2</sup> of showroom space
- **940** eksponata
- **120** ambijenata
- **3378** m<sup>2</sup> izložbenih površina
- **940** eksponata
- **120** ambijenata
- **3378** m<sup>2</sup> izložbenih površina

## PE Razstavno prodajni salon Kolpa - Ljubljana

BTC CITY, dvorana 1, Trg Mladih 3, 1000 Ljubljana



- preko **300** eksponatov Kolpasan
- **42** ambientov
- **1100** m<sup>2</sup> razstavnih površin
- over **300** Kolpasan items
- **42** showroom ideas
- **1100** m<sup>2</sup> of showroom space
- više od **300** eksponata Kolpasan
- **42** ambijenta
- **1100** m<sup>2</sup> izložbenih površina
- više od **300** eksponata Kolpasan
- **42** ambijenta
- **1100** m<sup>2</sup> izložbenih površina

## Razstavno prodajni salon Kolpa - Zagreb

Velimira Škorpika 11b, Family Mall, 10000 Zagreb



- preko **300** eksponatov Kolpasan
- **34** ambientov
- **950** m<sup>2</sup> razstavnih površin
- over **300** Kolpasan items
- **34** showroom ideas
- **950** m<sup>2</sup> of showroom space
- više od **300** eksponata Kolpasan
- **34** ambijenta
- **950** m<sup>2</sup> izložbenih površina
- više od **300** eksponata Kolpasan
- **34** ambijenta
- **950** m<sup>2</sup> izložbenih površina



## Tehnologija in materiali

Technology and materials

Tehnologija i materijali

Tehnologija i materijali

008



## Kerrock

je kompozitni material, ki je na trgu že vrsto let poznan kot trpežen in večern material. Sestavljen je iz aluminijevega hidroksida in polimernega veziva na bazi akrila. V programu Kolpasan iz njega izdelujemo kopalne kadi, tuš stebre, tuš kadi in umivalnike za kopalniško pohištvo. Za več informacij o Kerrocku obiščite spletno stran [www.kerrock.si](http://www.kerrock.si)

**Kerrock**  
Kerrock  
Kerrock  
Kerrock

## Kerrock

is a composite material that has been on the market for many years Composed of aluminium hydroxide and polymer acrylic-based binding substances, it is appreciated for its exceptional durability and longevity. Within the Kolpasan programme Kerrock is used for shower trays, shower columns, washbasins and bathroom furniture. For more information on Kerrock, please visit [www.kerrock.eu](http://www.kerrock.eu)

## Kerrock

je kompozitni materijal koji je na tržištu već godinama poznat kao izdržljiv i vječni materijal. Sastoji se od aluminijeva hidroksida i polimernog veziva na akrilnoj bazi. U programu Kolpasan od njega izrađujemo kupaonske kade, tuš stupove, tuš kade i umivaonike za kupaonski namještaj. Za više informacija o Kerrocku posjetite internetsku stranicu [www.kerrock.hr](http://www.kerrock.hr)

## Kerrock

je kompozitni materijal koji je na tržištu već niz godina poznat kao izdržljiv i večan materijal. Napravljen je od aluminijum hidroksida i polimernog vezivnog materijala na bazi akrila. U programu Kolpasan od njega pravimo kade za kupanje, tuš stubove, tuš kade i umivaonike za nameštaj za kupatilo. Za više informacija o Kerrocku posetite internet stranu [www.rs.kerrock.si](http://www.rs.kerrock.si)

Lastnosti Kerrocka | Kerrock properties | Svojstva Kerrocka | Osobine Kerrocka





## Tehnologija in materiali

Technology and materials

Tehnologija i materijali

Tehnologija i materijali

009



### Prijetnost na dotik

pleasant to touch

ugodan na dodir

prijatan na dodir

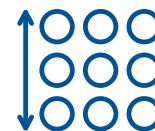

### Enakomerna struktura

uniform structure

jednolična struktura

jednolična struktura



### Enostavno za čiščenje, vzdrževanje

easy to clean, maintenance

lako se čisti, održava

lako se čisti, održava



### Samougasljiv

self-extinguishing

samogaseći

samogasiv



### Neporoznost

non-porous

neporoznost

nepozoran



### Nevidni spoji

invisible joints

nevidljivi spojevi

nevidljivi spojevi



### Kemijska in mehanska odpornost

chemically and mechanically resistant

kemijski i mehanički otporan

hemijski i mehanički otporan



### Možnosti obrezovnja tuš kadi

Shower tray trimming options

Mogućnost rezanja tuš kada po mjeri

Mogućnost rezanja na meru



## Tehnologija in materiali

Technology and materials

Tehnologija i materijali

Tehnologija i materijali

010

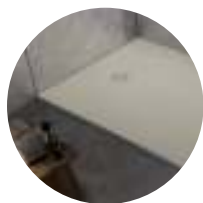

## Lahki liti marmor

Lahki liti marmor je do 40 % lažji od primerljivih izdelkov, kar omogoča lažjo manipulacijo in montažo. Inovativna formula omogoča cenovno dostopnejšo različico tuš kadi. Ohranil je trdnost, odpornost na udarce, kemikalije in temperaturo. Dobro zadržuje toploto ter je enostaven za čiščenje in vzdrževanje. V programu Kolpasan iz njega izdelujemo tuš kad Hopp.

**Lahki liti marmor**  
 Lightweight cast marble  
 Lagani lijevani mramor  
 Lagani liveni mermer

## Lightweight cast marble

Lightweight cast marble is up to 40% lighter than comparable products, which allows easier handling and installation. The innovative formula enables a more affordable version of the shower tray. It has retained strength, resistance to impacts, chemicals, and temperature. It retains heat well and is easy to clean and maintain. In the Kolpasan program, we use it to manufacture the Hopp shower tray.

## Lagani lijevani mramor

Laki Lijevani mramor koji je do 40% lakši od usporedivih proizvoda, što omogućuje lakšu manipulaciju i montažu. Inovativna formula omogućuje cjenovno pristupačniju verziju tuš kade. Zadržao je čvrstoću, otpornost na udarce, kemikalije i temperaturo. Dobro zadržava toplinu te je jednostavan za čišćenje i održavanje. U programu Kolpasan iz njega izrađujemo tuš kadu Hopp.

## Lagani liveni mermer

Liveni laki mermer je do 40% lakši od uporedivih proizvoda, što omogućava lakšu manipulaciju i montažu. Inovativna formula omogućava cenovno pristupačniju verziju tuš kade. Zadržao je čvrstinu, otpornost na udarce, hemikalije i temperaturo. Dobro zadržava toplinu i jednostavan je za čišćenje i održavanje. U programu Kolpasan iz njega izrađujemo tuš kadu Hopp.

Lastnosti lahkega litega marmorja | Lightweight cast marble properties | Svojstva lakog lijevanog mramora | Osobine lakog livenog mermera





## Tehnologija in materiali

Technology and materials

Tehnologija i materijali

Tehnologija i materijali

011



### Odporna reliefna površina

resistant relief surface

otporna reljefna površina

otporna reljefna površina



### Enostavno za čiščenje, vzdrževanje

easy to clean, maintenance

lako se čisti, održava

lako se čisti, održava



### Trajen in odporen na staranje

durable and age-resistant

trajan i ne stari

trajan je i ne stari



### Enostavna vgradnja

simple installation

jednostavna ugradnja

jednostavna ugradnja



### Kemijska odpornost

chemically resistant

kemijski otporan

hemijski otporan



### Enostavna sanacija poškodb

easy repair of damage

jednostavno popravljanje oštećenja

laka popravka oštećenja



### Možnosti obrezovnja tuš kadi

Shower tray trimming options

Mogućnost rezanja tuš kada po mjeri

Mogućnost rezanja na meru



### 4 barve

4 colours

4 boje

4 boje



## Tehnologija in materiali

Technology and materials

Tehnologija i materijali

Tehnologija i materijali

012



## Liti marmor

Liti marmor se ponaša z gladko in reliefno površino, ki je enostavna za čiščenje in vzdrževanje. Njegova trpežnost in odpornost na kemikalije zagotavljata dolgo življenjsko dobo. Poleg tega ga odlikuje enostavna vgradnja, kar zagotavlja hitro in enostavno montažo. V programu Kolpasan iz njega izdelujemo tuš kadi in umivalnike za kopalniško pohištvo.

**Liti Marmor**  
Cast marble  
Lijevani mramor  
Liveni mermer

## Cast marble

Cast marble features a smooth and textured surface that is easy to clean and maintain. Its durability and resistance to chemicals ensure a long lifespan. Additionally, it is characterized by easy installation, allowing for quick and simple assembly. In the Kolpasan program, we use it to manufacture shower trays and washbasins for bathroom furniture.

## Lijevani mramor

Lijevani mramor odlikuje gladka i reliefna površina koja se lako čisti i održava. Njegova trajnost i otpornost na kemikalije osiguravaju dug vijek trajanja. Osim toga, odlikuje ga jednostavna ugradnja što omogućuje brzu i laku montažu. U programu Kolpasan iz njega izrađujemo tuš kade i umivaonike za kupaonski namještaj.

## Liveni mermer

Liveni mermer odlikuje gladka i reliefna površina koja se lako čisti i održava. Njegova izdržljivost i otpornost na hemikalije obezbeđuju dug vek trajanja. Pored toga, odlikuje se jednostavnom ugradnjom, što omogućava brzu i laku montažu. U programu Kolpasan iz njega izrađujemo tuš kade i umivaonike za kupatilski nameštaj.

**Lastnosti litega marmorja** | Cast marble properties | Svojstva lijevanog mramora | Osobine livenog mermera





## Tehnologija in materiali

Technology and materials

Tehnologija i materijali

Tehnologija i materijali

013



### Odporna reliefna površina ali visok sijaj

resistant relief surface or high gloss finish

otporna reljefna površina ili visoki sjaj

otporna reljefna površina ili visoki sjaj



### Enostavno za čiščenje, vzdrževanje

easy to clean, maintenance

lako se čisti, održava

lako se čisti, održava



### Trajen in odporen na staranje

durable and age-resistant

trajan i ne stari

trajan je i ne stari



### Enostavna vgradnja

simple installation

jednostavna ugradnja

jednostavna ugradnja



### Kemijska odpornost

chemically resistant

kemijski otporan

hemijski otporan



### Enostavna sanacija poškodb

easy repair of damage

jednostavno popravljanje oštećenja

laka popravka oštećenja



### Možnosti obrezovnja tuš kadi

Shower tray trimming options

Mogućnost rezanja tuš kada po mjeri

Mogućnost rezanja na meru



### 3 barve (reliefna površina)

3 colours (relief surface)

3 boje (reljefna površina)

3 boje (reljefna površina)



## Tehnologija in materiali

Technology and materials

Tehnologija i materijali

Tehnologija i materijali

014



## Liti sanitarni akril

Liti sanitarni akril je najžlahtnejši polimerni material, ki se ponaša z visoko trpežnostjo in odpornostjo proti staranju. Njegova površina je prijetna na dotik in ima visok sijaj, poleg tega pa zaradi odlične toplotne izolacije učinkovito varčuje z energijo. Ker je obarvan po celi debelini, omogoča enostavno saniranje mehanskih poškodb, kar dodatno prispeva k njegovi dolgotrajni uporabnosti. V programu Kolpasan iz njega izdelujemo kopalne in tuš kadi.

**Liti sanitarni akril**  
Sanitary cast acrylic  
Sanitarni ljevani akril  
Sanitarni liveni akril

## Sanitary cast acrylic

Cast sanitary acrylic is the most refined polymer material, known for its high durability and resistance to aging. Its surface is pleasant to the touch and has a high gloss, while its excellent thermal insulation properties help save energy. Since it is colored throughout its entire thickness, it allows for easy repair of mechanical damage, further enhancing its long-lasting usability. In the Kolpasan program, we use it to manufacture bathtubs and shower trays.

## Sanitarni ljevani akril

Ljevani sanitarni akril je najplemenitiji polimerni material, poznat po visoki trajnosti i otpornosti na starenje. Njegova površina je ugodna na dodir i ima visoki sjaj, dok izvrsna toplotna izolacija pomaže u uštedi energije. Budući da je obojen kroz cijelu debljinu, omogućuje jednostavno saniranje mehaničkih oštećenja, čime se dodatno povećava njegova dugotrajna upotrebljivost. U programu Kolpasan iz njega izrađujemo kupaonske kade i tuš kade.

## Sanitarni liveni akril

Liveni sanitarni akril je najplemenitiji polimerni material, poznat po visoki trajnosti i otpornosti na starenje. Njegova površina je prijatna na dodir i ima visok sjaj, dok odlična toplotna izolacija pomaže u uštedi energije. Pošto je obojen kroz celu debljinu, omogućava lako saniranje mehaničkih oštećenja, što dodatno doprinosi njegovoj dugotrajnoj upotrebljivosti. U programu Kolpasan iz njega izrađujemo kade za kupanje i tuš kade.

**Lastnosti litega sanitarnega akrila** | Sanitary cast acrylic properties | Svojstva ljevanog sanitarnog akrila | Osobine livenog sanitarnog akrila





## Tehnologija in materiali

Technology and materials

Tehnologija i materijali

Tehnologija i materijali

015



### Najžlahtnejši polimerni material

the most precious polymer material

najplemenitiji polimerni material

najplemenitiji polimerni material



### Trajen in odporen na staranje

durable and age-resistant

trajan i ne stari

trajan je i ne stari



### Prijetnost na dotik

pleasant to touch

ugodnost na dodir

prijatan na dodir



### Visok sijaj

high gloss finish

visok sjaj

ima visoki sjaj



### Toplotna izolacija in energetska varčnost

thermal insulation and energy efficiency

toplinska izolacija i energetska učinkovitost

toplotna izolacija i energetska efikasnost

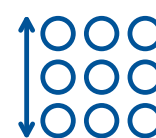

### Enakomerna struktura

uniform structure

jednolika struktura

jednolična struktura



### Kemijska in mehanska odpornost

chemically and mechanically resistant

kemijski i mehanički otporan

hemijski i mehanički otporan



### Enostavna sanacija poškodb

easy repair of damage

jednostavno popravljanje oštećenja

laka popravka oštećenja



## Tehnologija in materiali

Technology and materials

Tehnologija i materijali

Tehnologija i materijali

016



**Modificirani akril**  
Modified acrylic  
Modificirani akril  
Modifikovani akril

## Modificirani akril

Modificiran akril ima odporno reliefno površino, ki omogoča lahkotno čiščenje. Njegova velika žilavost in odpornost na raze zagotavljata trpežnost in dolgo obstojnost materiala. Poleg tega je odličen toplotni izolator, kar prispeva k boljši energetski učinkovitosti. V programu Kolpasan iz njega izdelujemo tuš kad Serra.

## Modified acrylic

Modified acrylic has a durable textured surface that allows for easy cleaning. Its high toughness and resistance to scratches ensure the material's durability and long-lasting quality. Additionally, it is an excellent thermal insulator, contributing to better energy efficiency. In the Kolpasan program, we use it to manufacture the Serra shower tray.

## Modificirani akril

Modificirani akril ima otpornu reljefnu površinu koja omogućuje jednostavno čišćenje. Njegova velika žilavost i otpornost na ogrebotine osiguravaju trajnost i dugotrajnost materijala. Osim toga, izvrstan je toplinski izolator, što pridonosi boljoj energetskoj učinkovitosti. U programu Kolpasan iz njega izrađujemo tuš kadu Serra.

## Modifikovani akril

Modifikovani akril ima otpornu reljefnu površinu koja omogućava lako čišćenje. Njegova velika žilavost i otpornost na ogrebotine osiguravaju trajnost i dugovečnost materijala. Pored toga, odličan je toplotni izolator, što doprinosi boljoj energetskoj efikasnosti. U programu Kolpasan iz njega izrađujemo tuš kadu Serra.

**Lastnosti modificiranega akrila** | Modified acrylic properties | Svojstva modificiranog akrila | Osobine modifikovanog akrila





## Tehnologija in materiali

Technology and materials

Tehnologija i materijali

Tehnologija i materijali

017



### Odporna reliefna površina

resistant relief surface  
otporna reljefna površina  
otporna reljefna površina



### Velika žilavost materiala

high material resistance  
visoka žilavost materijala  
visoka otpornost materijala



### Enostavno za čiščenje, vzdrževanje

easy to clean, maintenance  
lako se čisti, održava  
lako se čisti, održava



### Toplotna izolacija in energetska varčnost

thermal insulation and energy efficiency  
toplinska izolacija i energetska učinkovitost  
toplotna izolacija i energetska efikasnost



### Mehanska odpornost

mechanically resistant  
mehanički otporan  
mehanički otporan

# Unique by Kolpasan

018



## Kopalniško pohištvo po meri

**Unique by Kolpasan** - pohištvo, izdelano po meri, vam omogoča, da izkoristite vsak centimeter svoje kopalnice. Za dodatne informacije obiščite našo spletno stran [www.unique.kolpasan.si/sl](http://www.unique.kolpasan.si/sl)

## Customised bathroom furniture

**Unique by Kolpasan** - custom made furniture allows you to make the most of every inch of your bathroom. For further information please visit our website [www.unique.kolpasan.si/en](http://www.unique.kolpasan.si/en)

## Kupaonski namještaj po mjeri

**Unique by Kolpasan** - namještaj po mjeri vam omogočuje da iskoristite svaki centimeter svoje kupaonice. Za dodatne informacije posjetite našu internetsku stranico [www.unique.kolpasan.si/hr](http://www.unique.kolpasan.si/hr)

## Kupatila po meri

**Unique by Kolpasan** - nameštaj po meri vam omogočava da maksimalno iskoristite svaki centimeter svog kupatila. Za dodatne informacije posetite našu internet stranico [www.unique.kolpasan.si/sr](http://www.unique.kolpasan.si/sr)



reddot winner 2025



**BIG SEE  
Product Design  
Award 2024  
Winner**



# unique

by Kolpasan



**Ustvari svoj 3D izris**  
Create your own 3D render  
Izradite vlastiti 3D prikaz  
Kreirajte svoj 3D nacrt





# 01

**Masažne in kopalne kadi**  
Massage and bathtubs  
Masažne i kupaoničke kade  
Masažne i kade za kupanje

## Kopalna kad kot prostor intime

S kopalno kadjo Kolpasan si v kopalnici ustvarimo naše svetišče za razvajanje in sprostitvev. Topla voda zmanjšuje stres, prebuja občutke, nas sprošča in vesplošno vpliva na naše boljše počutje. V njem si ustvarimo naš osebni prostor v katerem se odmaknemo od zunanjega sveta, sprostimo in obnovimo naše notranje ravnovesje.

## Bathtub as a space of intimacy

With the Kolpasan bathtub, you create your personal sanctuary of indulgence and relaxation. Warm water reduces stress, heightens senses, relaxes us and generally affects our well being. It becomes our personal space in which to escape from the outside world as well as unleash and restore our internal balance.

## Kada kao prostor intime

S kadom za kupanje Kolpasan stvaramo naš intiman prostor za ugađanje i opuštanje u kupaonici. Topla voda smanjuje stres, budi osjećaje, opušta nas i općenito djeluje tako da se bolje osjećamo. U njoj stvaramo naš osobni prostor u kojem se izdvajamo od vanjskog svijeta, opuštamo i obnavljamo našu unutarnju ravnotežu.

## Kada kao prostor intime

Sa Kolpasan kadom, stvaramo svoje utočište za udobnost i opuštanje u kupatilu. Topla voda smanjuje stres, pojačava čula, opušta nas i generalno utiče na naše blagostanje. U njoj stvaramo naš lični prostor gdje se odvajamo od spoljašnjeg sveta, opuštamo i obnavljamo našu unutrašnju ravnotežu.



\* **Kerrock** | Kerrock | Kerrock | Kerrock  
liti sanitarni akril | cast sanitary acrylic | lijevani sanitarni akril | liveni sanitarni akril

\*\* **masažni sistemi** | massage systems | masažni sistemi | sistemi za masažu





# 01





## KOPALNE KADI / BATHTUBS KUPAONSKE KADE / KADE ZA KUPANJE



- **možnost izbire med 3 masažnimi sistemi**
- a choice of **3** massage systems
- možnost odabira između **3** masažnih sustava
- mogućnost izbora između **3** masažna sistema



- **možnosti izbire med različnimi materiali (Kerrock in sanitarni akril)**
- a choice of different materials (Kerrock and sanitary cast acrylic)
- možnosti odabira između različnih materijala (Kerrock i sanitarni ljevani akril)
- mogućnost izbora između različnih materijala (Kerrock, i sanitarni liveni akril)



- **ergonomska oblika s čistimi geometrijskim oblikami**
- ergonomic form with pure geometric lines
- ergonomski oblik s čistim geometrijskim oblicima
- ergonomski oblik sa čistim geometrijskim oblicima



- **možnost nadgradnje kadi z nadstandardnimi elementi (masažni sistemi, armature, sedeži in vzglavniki)**
- a large variety of bathtub accessories available (massage systems, faucets, seats and headrests)
- možnost nadgradnje kade s dodatnim elementima (masažni sustavi, armature, sjedala i jastuci)
- mogućnost nadgradnje kade sa vanstandardnim elementima (masažni sistemi, armature, sedišta i nasloni za glavu)



- **možnost nadgradnje s tuš paravani in kabinami**
- a selection of different screens and enclosures
- mogućnost nadgradnje s paravanima i kabinama za tuš-kade
- mogućnost nadgradnje sa tuš paravanima i kabinama

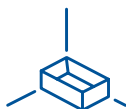

- **različne možnosti postavitve in vgradnje**
- various options for installation
- različite mogućnosti postavljanja i ugradnje
- različite mogućnosti montaže i ugradnje

50

- **več kot 50 modelov kopalnih kadi za opremo najrazličnejših vrst kopalnic**
- more than **50** models of bathtubs for a variety of bathroom layouts
- više od **50** modela kupaonskih kada za opremanje najrazličitijih vrsta kupaonica
- više od **50** modela kada za kupanje za opremanje najrazličitijih vrsta kupatila



- **možnosti obrezovanja kopalne kadi, pri določenih modelih**
- bathtub trimming options of certain models
- mogućnost rezanja kada za kupanje, kod određenih modela
- mogućnosti rezanja kada za kupanje, kod određenih modela



- **kromoterapija**
- chromotherapy
- kromoterapija
- hromoterapija



## Tehnologija in materiali

Technology and materials

Tehnologija i materijali

Tehnologija i materijali

024

### Možnosti vgradnje | Installation options | Mogućnosti ugradnje | Mogućnosti ugradnje

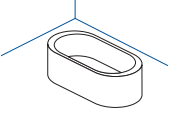
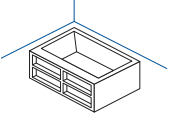
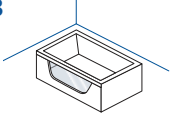
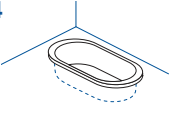
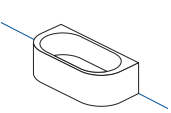
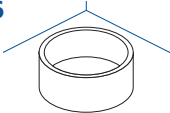
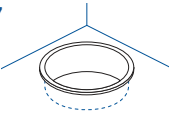
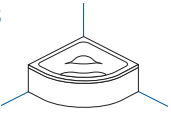
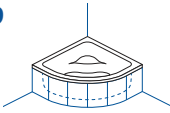
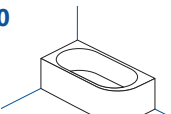
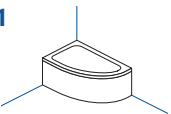
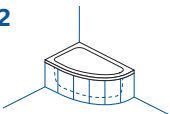
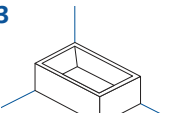
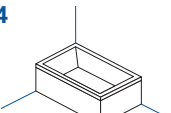
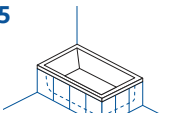
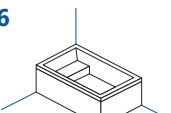
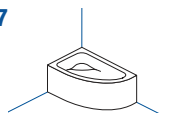
- |  |   |   |
|--|---|---|
| <p><b>1</b></p>  <ul style="list-style-type: none"> <li>• <b>samostoječa</b></li> <li>• freestanding</li> <li>• samostoječa</li> <li>• samostoječa</li> </ul>  | <p><b>2</b></p>  <ul style="list-style-type: none"> <li>• <b>police</b></li> <li>• shelves</li> <li>• police</li> <li>• police</li> </ul>  | <p><b>3</b></p>  <ul style="list-style-type: none"> <li>• <b>transparentna akrilna obloga</b></li> <li>• transparent acrylic panel</li> <li>• prozorna akrilna obloga</li> <li>• transparentna akrilna obloga</li> </ul> |
| <p><b>4</b></p>  <ul style="list-style-type: none"> <li>• <b>vgradna</b></li> <li>• built-in</li> <li>• ugradbena</li> <li>• ugradna</li> </ul>  | <p><b>5</b></p>  <ul style="list-style-type: none"> <li>• <b>ob steni, brez vidnega spoja</b></li> <li>• one wall, seamless</li> <li>• uz zid, bez vidljivog spoj</li> <li>• do zida, bez vidljivog spo</li> </ul> | <p><b>6</b></p>  <ul style="list-style-type: none"> <li>• <b>okrugla</b></li> <li>• round</li> <li>• okrugla</li> <li>• okrugla</li> </ul>   |
| <p><b>7</b></p>  <ul style="list-style-type: none"> <li>• <b>okrugla, vgradna</b></li> <li>• round, built-in</li> <li>• okrugla, ugradbena</li> <li>• okrugla, ugradna</li> </ul>  | <p><b>8</b></p>  <ul style="list-style-type: none"> <li>• <b>kotna, sedež</b></li> <li>• corner, seat</li> <li>• kutna, sjedalo</li> <li>• ugaona, sadište</li> </ul>  | <p><b>9</b></p>  <ul style="list-style-type: none"> <li>• <b>kotna, vgradna, sedež</b></li> <li>• corner, built-in, seat</li> <li>• kutna, ugradbena, sjedalo</li> <li>• ugaona, ugradna, sadište</li> </ul>             |
| <p><b>10</b></p>  <ul style="list-style-type: none"> <li>• <b>asimetrična, brez vidnega spoja</b></li> <li>• asymmetric, seamless</li> <li>• asimetrična, bez vidljivog spoja</li> <li>• asimetrična, bez vidljivog spoja</li> </ul> | <p><b>11</b></p>  <ul style="list-style-type: none"> <li>• <b>asimetrična</b></li> <li>• asymmetric</li> <li>• asimetrična</li> <li>• asimetrična</li> </ul>   | <p><b>12</b></p>  <ul style="list-style-type: none"> <li>• <b>asimetrična, vgradna</b></li> <li>• asymmetric, built-in</li> <li>• asimetrična, ugradbena</li> <li>• asimetrična, ugradna</li> </ul>                      |
| <p><b>13</b></p>  <ul style="list-style-type: none"> <li>• <b>klasična, brez vidnega spoja</b></li> <li>• classic, seamless</li> <li>• klasična, bez vidljivog spoja</li> <li>• klasična, bez vidljivog spoja</li> </ul>           | <p><b>14</b></p>  <ul style="list-style-type: none"> <li>• <b>klasična</b></li> <li>• classic</li> <li>• klasična</li> <li>• klasična</li> </ul>   | <p><b>15</b></p>  <ul style="list-style-type: none"> <li>• <b>klasična, vgradna</b></li> <li>• classic, built-in</li> <li>• klasična, ugradbena</li> <li>• klasična, ugradna</li> </ul>                                |
| <p><b>16</b></p>  <ul style="list-style-type: none"> <li>• <b>sedež</b></li> <li>• seat</li> <li>• sjedalo</li> <li>• sadište</li> </ul>   | <p><b>17</b></p>  <ul style="list-style-type: none"> <li>• <b>sedež</b></li> <li>• seat</li> <li>• sjedalo</li> <li>• sadište</li> </ul>   |   |

### Barva zunanjega dela kopalne kadi | Colour of the outer part of the bathtub | Boja vanjskog dijela kade za kupanje | Boja spoljnog dela kade za kupanje

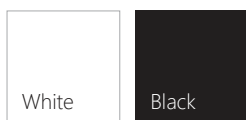

### Opcije | Options | Opcije | Opcije



- **Možnost vgradnje masažnega sistema (kopalne kadi z oblogo).**
- Option of installation of a massage system (for bathtubs with panel).
- Mogućnost ugradnje sistema za masažu (za kupaonske kade s oblogom).
- Mogućnost ugradnje sistema za masažu (za kade sa oblogom).



- **Možnost vgradnje tuš kabine**
- Option of installation of shower enclosure
- Mogućnost ugradnje tuš kabine
- Mogućnost nadgradnje tuš kabine



- **Kopalniški sedeži**
- Bathroom seats
- Kupaonska sjedala
- Sedišta za kupatilo



- **Kromoterapija**
- Chromotherapy
- Kromoterapija
- Hromoterapija



- **Možnost obrezovanja na željeno dimenzijo**
- Trimming options
- Možnost prerezovanja
- Mogućnost sečenja



- **Možnost vgradnje armature s tuš ročico (kopalne kadi z oblogo).**
- Option of installation of mounting with a hand shower (for bathtubs with panel).
- Mogućnost ugradnje miješalice s tušom (za kupaonske kade s oblogom).
- Mogućnost nadgradnje baterije sa tuš ručicom (za kade sa oblogom).

- \* • **Samo pri določenih dimenzijah**
- Only for certain dimensions
- Samo za određene dimenzije
- Samo za određene dimenzije



## Možnosti obrezovanja kopalnih kadi

Bathtub trimming options

Mogućnost rezanja kupaonskih kade

Mogućnosti korigovanja kade za kupanje

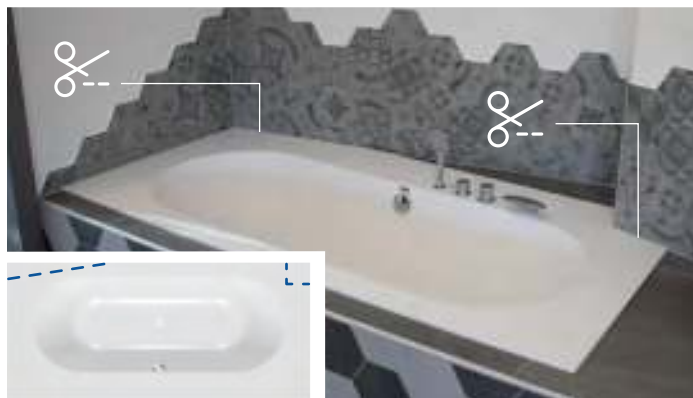

### Obrezovnje kopalnih kadi ATYS 200x100 iz Kerrocka

Za primere, ko arhitekturne lastosti kopalnic, zlasti pri obnovah starejših objektov, ne dovoljujejo vgradnje klasičnih kadi iz rednega programa, nudimo našim strankam možnost prilagoditve določenih kopalnih kadi njenim specifičnim zahtevam. Za dodatne informacije glede modelov in možnosti, obiščite našo spletno stran

[www.kolpasan.si](http://www.kolpasan.si)

### Bathtub trimming ATYS 200x100 made from Kerrock

For situations where the architectural properties of bathrooms, especially in the renovation of older buildings, do not allow the installation of classic bathtubs from the regular program, we provide our customers with the possibility of adapting certain bathtubs to their specific requirements. For further information on the models and options, please visit our website [www.kolpasan.eu](http://www.kolpasan.eu)

### Prilagođavanje kade za kupanje ATYS 200x100 od Kerrocka

U slučajevima kada arhitektonska svojstva kupaonica, posebno prilikom renoviranja starijih objekata, ne dopuštaju ugradnju klasičnih kade iz dovnog programa, našim kupcima pružamo mogućnost prilagođavanja određenih kade za kupanje njihovim specifičnim zahtjevima. Za dodatne informacije o modelima i mogućnostima posjetite našu internetsku stranicu

[www.kolpasan.hr](http://www.kolpasan.hr)

### Prilagođavanje kade ATYS 200x100 od Kerrocka

U slučajevima kada arhitektonske karakteristike kupatila, posebno pri renoviranju starijih objekata, ne dozvoljavaju ugradnju klasičnih kade iz redovnog programa, našim klijentima nudimo mogućnost prilagođavanja određenih modela kade njihovim specifičnim zahtevima. Za dodatne informacije o modelima i mogućnostima posetite našu veb-stranicu [www.kolpasan.rs](http://www.kolpasan.rs)



## Antislip premaz (samo za sanitarni akril)

Antislip coating (only for sanitary acrylic)

Antislip premaz (samo za sanitarni akril)

Antislip premaz (samo za sanitarni akril)

025



### PREDNOSTI ANTISLIP PREMAZA

- neдрseća površina pri uporabi na tuš kadi oz kopalni kadi
- razvito za kopalniške oz wellness prostore ter hotelske kopalnice

Veća varnost:

- pri vstopu in izstopu iz tuš kadi oz kopalne kadi
- med kopanjem in tuširanjem

### ADVANTAGES OF THE ANTISLIP COATING

- non-slip surface in shower trays and bathtubs
- developed for bathrooms, wellness and hotel bathrooms

Improved safety:

- when entering or exiting the shower or bath tub
- during showering and bathing

### PREDNOSTI ANTISLIP PREMAZA

- protuklizna površina kod upotrebe na kupaoničkoj odnosno tuš-kadi
- dizajniran za kupaonske odnosno wellness prostore i hotelske kupaonice

Veća sigurnost:

- pri ulasku i izlasku iz tuš-kade ili kupaoničke kade,
- za vrijeme kupanja i tuširanja.

### PREDNOSTI ANTISLIP PREMAZA

- neklizeća površina prilikom korišćenja na tuš kadi odn. kadi za kupanje
- razvijeno za kupatilske odn. wellness prostorije i hotelska kupatila

Veća bezbednost:

- prilikom ulaska i izlaska iz tuš kade odn. kade za kupanje
- tokom kupanja i tuširanja

**K** **Kerrock**  
 Kerrock  
 Kerrock  
 Kerrock

**kerrock**  
 by KOLPA



**TRISTAN-FS**  
 197x117



**COPELIA-FS**  
 180x80



**COPELIA LUX-FS**  
 180x100



**COPELIA LIGHT-FS**  
 180x80



**GLORIA-FS**  
 180x80



**BLANCHE-FS**  
 180x85

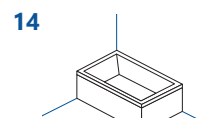
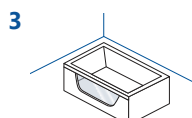
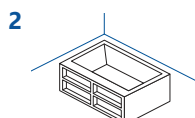
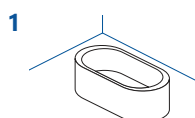



**RAMONA BATHTUB-FS**

180x80



**ATYS DUO-FS**

174x70



**ATYS-FS**

180x85



**ATYS/O**

180x85



**ATYS**

200x100

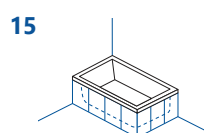

# A

## Liti sanitarni akril

Sanitary cast acrylic  
Sanitarni ljevani akril  
Sanitarni liveni akril



**ADAM & EVA-FS**

190x120



**COMODO-FS**

185x90



**SOFT-FS**

180x80



**SOFT**

180x80



**PANDORA-FS**

173x78 / 163x68



**MEDEA-FS**

170x90

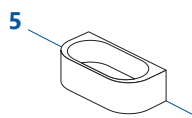
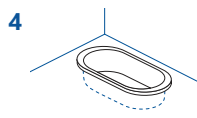
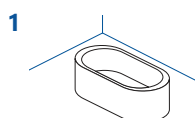



**DALIA-FS**  
170x80



**LUX-FS**  
170x85



**LUX**  
170x85



**BETTY-FS**  
170x73 / 160x73 / 150x63



**ELEKTRA-SP**  
185x85 / 175x75



**DREAM-SP**  
180x80 / 170x75

# A

## Liti sanitarni akril

Sanitary cast acrylic  
Sanitarni ljevani akril  
Sanitarni liveni akril

new



**LENOX-SP**

170x80, 160x80



**OPERA**

Ø180



**GAIA**

160x160



**DOLORES**

150x150 / 140x140 / 130x130



**DIVANTE**

140x140



**ROYAL**

130x130 / 120x120

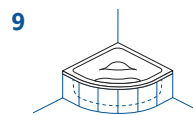
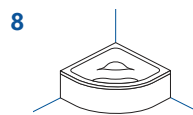
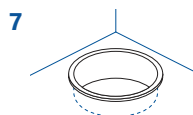
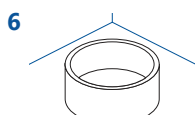
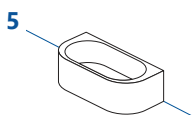



**ELEKTRA-SP-L**  
185x85 / 175x75



**ELEKTRA-SP-D**  
185x85 / 175x75



**DREAM-SP-L**  
180x80 / 170x75



**DREAM-SP-D**  
180x80 / 170x75

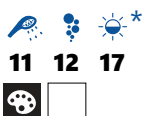

**LIBRETTO-L**  
170x110 / 160x100

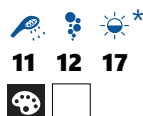

**LIBRETTO-D**  
170x110 / 160x100

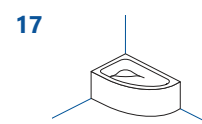
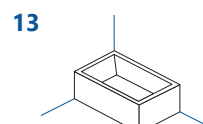
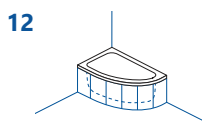
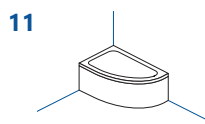
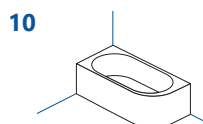

# A

## Liti sanitarni akril

Sanitary cast acrylic  
Sanitarni ljevani akril  
Sanitarni liveni akril



**BEATRICE-L**  
170x110 (70)



**BEATRICE-D**  
170x110 (70)



**CALANDO-L**  
160x90 / 150x85



**CALANDO-D**  
160x90 / 150x85

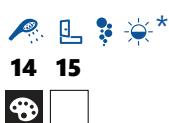

**BETTY**  
200x90 / 190x90

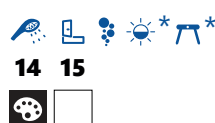

**BETTY**  
180x90 / 180x80 / 170x80  
170x75 / 170x70 / 160x70 / 150x70  
140x70 / 130x70 / 120x70

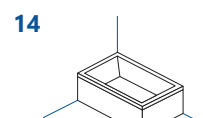
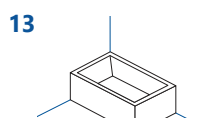
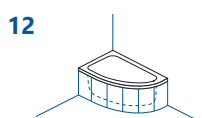
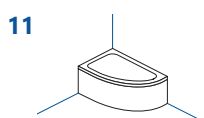



15

**BETTY E2**

180x80 / 170x80 / 170x75  
170x70



14 15

**ADAM & EVA**

195x125



14 15

**NABUCCO**

190x120

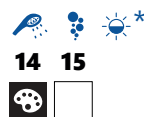

14 15

**EVITA**

190x90 / 180x85 / 180x80  
170x80



14 15

**ELEKTRA**

190x90 / 180x80 / 170x80  
170x75 / 170x70 / 160x75



13 14 15

**SAMSON**

180x160

15

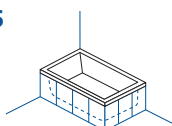

17

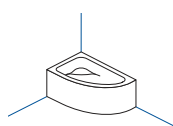

# A

## Liti sanitarni akril

Sanitary cast acrylic  
Sanitarni ljevani akril  
Sanitarni liveni akril



14 15



### EVELIN BATHTUB

170x75 / 170x70 / 160x70  
150x70 / 140x70



14 15



### TAMIA

180x80 / 170x75 / 170x70  
160x70 / 150x70 / 140x70



14 15 16 17



### TAMIA/S

140x70



15



### MINI

100x70

14

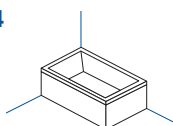

15

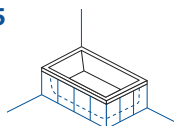

16

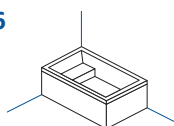

17

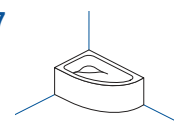





# 02

**Masažni stebri, tuš stebri**  
Massage columns, shower columns  
Masažni stupovi, tuš stupovi  
Masažni stubovi, stubovi za tuširanje

## Masažni stebri za popolno sprostitiv

Masažni stebri Kolpasan nam omogočajo več kot zgolj navadno umivanje ali tuširanje – je nadgradnja rituala čiščenja, ob katerem se sprostimo, sproščamo napetost, blažimo stres in stimuliramo krvni obtok.

## Massage columns for complete relaxation

Kolpasan massage columns are not just about washing or showering – they are an upgrade of the cleansing ritual, during which we relax, release tension, relieve stress and stimulate blood circulation.

## Masažni stupovi za potpuno opuštanje

Masažni stupovi Kolpasan pružaju nam više od samog kupanja ili tuširanja – to je nadogradnja rituala čišćenja, tijekom kojeg se opuštamo, oslobađamo napetosti, oslobađamo stresa i potičemo cirkulaciju.

## Masažni stubovi za potpuno opuštanje

Masažni stubovi Kolpasan nam nude više od samog kupanja ili tuširanja – to je nadogradnja rituala čišćenja, tokom kojeg se opuštamo, oslobađamo napetosti, oslobađamo se stresa i stimuliramo cirkulaciju.



\* **Kerrock** | Kerrock | Kerrock | Kerrock

\*\* **masažni sistemi** | massage systems | masažni sistemi | sistemi za masažu





# 02

038



## MASAŽNI STEBRI / MASSAGE COLUMNS MASAŽNI STUPOVI / MASAŽNI STUBOVI



- **usklajeno delovanje različnih sistemov ponuja različne zdravstveno dokazane terapevtske učinke in skrbi za vaše dobro počutje**
- synchronised operation of different systems offers various medically proven therapeutic effects and takes care of your wellbeing
- usklajeno delovanje različnih sistema pruža različite zdravstveno dokazane terapevtske efekte i vodi računa o vašem dobrom osjećaju
- usklađen rad različnih sistema nudi različite zdravstveno dokazane terapijske efekte i vodi računa o vašem dobrom osjećaju



- **učinek tople vode in strateško postavljenih vodnih curkov skrbi za našo vitalnost ter sproža občutek sproščenosti in ugodja**
- warm water and strategically placed water jets improves vitality and delivers the feeling of relaxation and pleasure
- učinak tople vode i strateški pozicioniranih vodenih mlaznica vodi računa o našoj vitalnosti i potiče prijatan osećaj opuštenosti
- efekat tople vode i strateški raspoređenih vodenih mlaznica brine o našoj vitalnosti i podstiče prijatan osećaj opuštenosti.



- **masaža telesa pozitivno vpliva na naš krvni obtok, zmanjšuje fizične bolečine in odpravlja čustveno napetost, ki nam jo ustvarja vsakdanji stres**
- body massage has a positive effect on the blood flow, and relieves pain and emotional tension caused by everyday stress
- masaža tijela pozitivno utiče na naš krvotok, smanjuje fizičke bolove i otklanja emotivnu napetost koju nam donosi svakodnevni stres
- masaža tela pozitivno utiče na naš krvotok, smanjuje fizičke bolove i otklanja emotivnu napetost koju nam donosi svakodnevni stres



- **izdelki omogočajo enostavno vzdrževanje in čiščenje**
- our products are easy to maintain and clean
- proizvodi omogočavaju jednostavno održavanje i čišćenje
- proizvodi omogućuju jednostavno održavanje i čišćenje



- **nudimo vam servis in rezervne dele**
- we offer you service i spare parts
- nudimo vam servis i rezervne dijelove
- nudimo vam servis i rezervne delove

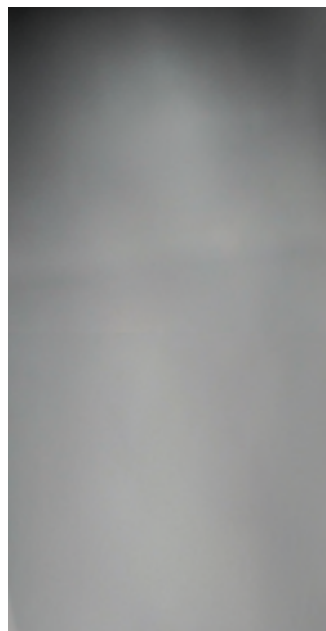

# Solano 1400 2f

040

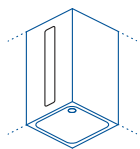

## Barvi tuš stebra / Shower column colours

Boje stupova za tuširanje / Boje stuba za tuširanje



## Funkcije sistema:

- 2 funkcijska termostatska armatura
  - prha za glavo
  - ročna prha
- vgradnja: stenska
- 2 Kerrock barvi

## System functions:

- 2-functional thermostatic fittings
  - head shower sprayer
  - hand shower sprayer
- installation: wall
- 2 different Kerrock colours

## Funkcije sustava:

- Termostatska armatura 2 funkcije
  - tuš za glavu
  - ručni tuš
- ugradnja: zidna
- 2 različite Kerrock boje

## Funkcije sistema:

- 2-funkcijska termostatska armatura
  - tuš za glavu
  - ručni tuš
- ugradnja: zidna
- 2 različiti Kerrock boja

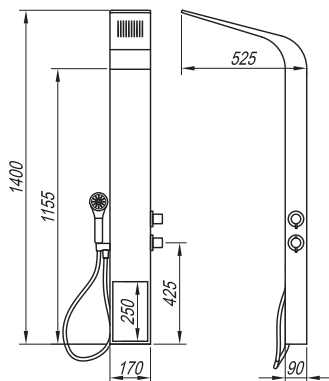

# Slim 1600 2f

041

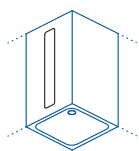

## Barvi tuš stebra / Shower column colours

Boje stupova za tuširanje / Boje stuba za tuširanje



109 - White



9252 - Andesite

## Funkcije sistema:

- 2 funkcijska termostatska armatura
  - prha za glavo
  - ročna prha
- vgradnja: stenska
- 2 Kerrock barvi

## System functions:

- 2-functional thermostatic fittings
  - head shower sprayer
  - hand shower sprayer
- installation: wall
- 2 different Kerrock colours

## Funkcije sustava:

- Termostatska armatura 2 funkcije
  - tuš za glavu
  - ručni tuš
- ugradnja: zidna
- 2 različite Kerrock boje

## Funkcije sistema:

- 2-funkcijska termostatska armatura
  - tuš za glavu
  - ručni tuš
- ugradnja: zidna
- 2 različiti Kerrock boja

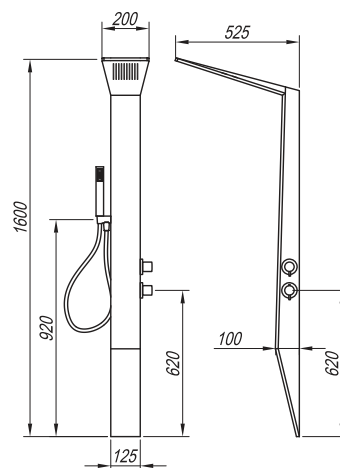

# Zonda flat 1600 3f

042

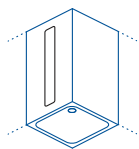

## Barvi masažnega stebra / Massage column colours

Boje masažnog stupa / Boje masažnog stuba



## Funkcije sistema:

- 3 funkcijska termostatska armatura
  - prha za glavo
  - masaža zgornjega dela telesa
  - masaža spodnjega dela telesa
- ročna prha
- vgradnja: stenska
- 2 Kerrock barvi

## System functions:

- thermostatic mixer with 3 functions
  - head shower sprayer
  - upper body massage
  - lower body massage
- hand shower sprayer
- installation: wall
- 2 different Kerrock colours

## Funkcije sustava:

- termostatska 3 funkcijska armatura
  - tuš za glavu
  - masaža gornjeg dijela tijela
  - masaža donjeg dijela tijela
- ručni tuš
- ugradnja: zidna
- 2 različite Kerrock boje

## Funkcije sistema:

- 3-funkcionalna termostatska armatura
  - tuš za glavu
  - masaža gornjeg dela tela
  - masaža donjeg dela tela
- ručni tuš
- ugradnja: zidna
- 2 različitim Kerrock boja

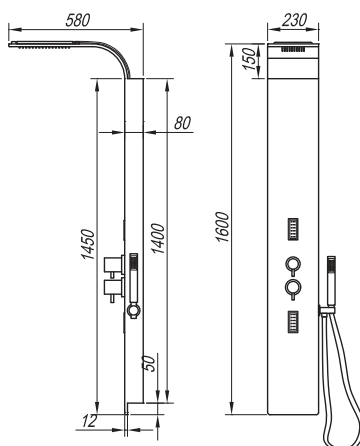

# Zonda 1500 3f

043

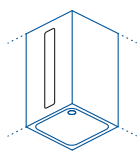

## Barvi masažnega stebra / Massage column colours

Boje masažnog stupa / Boje masažnog stuba



109 - White



9252 - Andesite

## Funkcije sistema:

- 3 funkcijska termostatska armatura
  - prha za glavo
  - masaža zgornjega dela telesa
  - masaža spodnjega dela telesa
  - ročna prha
- vgradnja: stenska
- 2 Kerrock barvi

## System functions:

- thermostatic mixer with 3 functions
  - head shower sprayer
  - upper body massage
  - lower body massage
  - hand shower sprayer
- installation: wall
- 2 different Kerrock colours

## Funkcije sustava:

- termostatska 3 funkcijska armatura
  - tuš za glavu
  - masaža gornjeg dijela tijela
  - masaža donjeg dijela tijela
  - ručni tuš
- ugradnja: zidna
- 2 različite Kerrock boje

## Funkcije sistema:

- 3-funkcionalna termostatska armatura
  - tuš za glavu
  - masaža gornjeg dela tela
  - masaža donjeg dela tela
  - ručni tuš
- ugradnja: zidna
- 2 različiti Kerrock boja

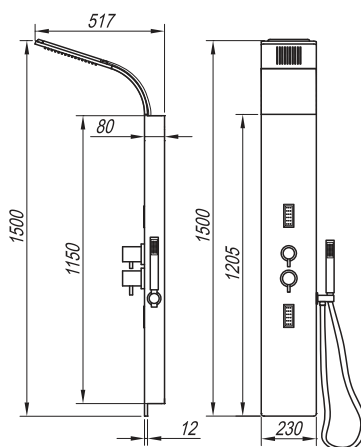



# 03

**Tuš kadi**  
Shower trays  
Tuš kade  
Tuš kade

## Praktičnost tuš kadi

Če nam hiter način življenja ne dovoljuje, da bi se ob večerih namakali v kopeli, je idealna in najbolj praktična rešitev tuš kad s tuš kabino. Pomembno je, da se med sproščujočim dnevnim ritualom prhanja počutimo varne, zato izberemo tuš kad, ki nam najbolj ustreza ter nam ob pomanjkanju časa olajša čiščenje in vzdrževanje.

## Practicality of shower trays

If the fast pace of life does not allow us to soak in a bath in the evenings, the ideal and most practical solution is a Kolpasan shower tray with enclosure. It is important to feel safe during relaxing daily showering rituals, therefore we choose the shower tray that works best for us and makes cleaning and maintenance easy for us when we are short of time.

## Praktičnost tuš kada

Ako nam ubrzani način života ne dopušta navečer opuštanje u toploj kupki navečer, idealno i najpraktičnije rješenje je tuš kada s kabinom Kolpasan. Važno je da se tijekom opuštajućeg dnevnog rituala tuširanja osjećamo sigurno i zato biramo tuš kadu koja nam najbolje odgovara te nam u nedostatku vremena olakšava čišćenje i održavanje.

## Praktičnost tuš kada

Ako nam užurbani tempo života ne ostavlja dovoljno vremena za večernje opuštanje u kadi, idealno i najpraktičnije rešenje je Kolpasan tuš-kada sa kabinom. Važno je da se tokom svakodnevnih rituala tuširanja osećamo bezbedno i opušteno, zato biramo tuš-kadu koja nam najbolje odgovara i koja ne zahteva mnogo vremena jer se lako održava i čisti.

- \* **Kerrock** | Kerrock | Kerrock | Kerrock
- lahki liti marmor** | Lightweight cast marble | lagani lijevani mramor | lagani liveni mermer
- liti marmor** | cast marble | lijevani mramor | liveni mermer
- liti sanitarni akril** | cast sanitary acrylic | lijevani sanitarni akril | liveni sanitarni akril
- \*\* **modificirani akril** | modified acrylic | modificirani akril | modifikovani akril



\*

\*\*



# 03

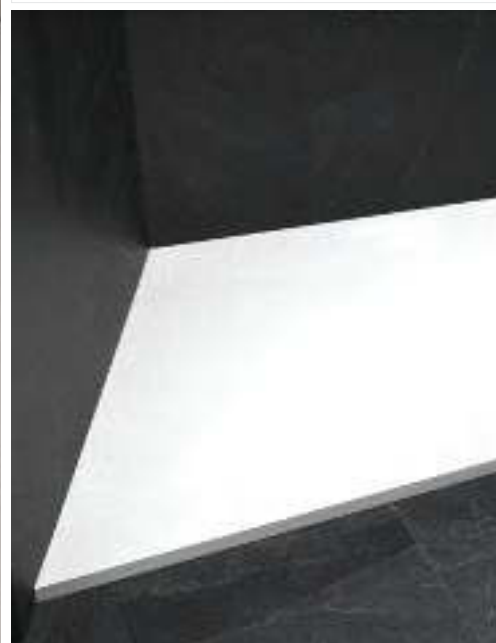



## TUŠ KADI / SHOWER TRAYS TUŠ KADE / TUŠ KADE



- **možnosti izbire med različnimi materiali (Kerrock, lahki liti marmor, liti marmor, modificirani akril in liti sanitarni akril)**
- the choice between different materials (Kerrock, lightweight cast marble, cast marble, modified acrylic and cast sanitary acrylic)
- možnost izbora između materijala (Kerrock, lagani lijevani mramor, lijevani mramor, modificirani akril i lijevani sanitarni akril)
- možnost odabira između različitih materijala (Kerrock, lagani liveni mermer, liveni mermer, modificirani akril i liveni sanitarni akril)

### 30

- **več kot 30 modelov tuš kadi za opremo najrazličnejših vrst kopalnic**
- more than **30** models of shower trays for equipment of a wide range of bathrooms
- više od **30** modela tuš kada za opremanje raznih vrsta kupaonica
- više od **30** modela tuš-kada za opremanje različitih vrsta kupatila

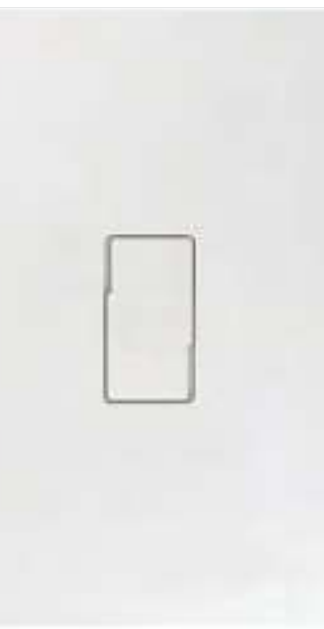

- **zaradi nizkega roba je vstop v tuš kadico lažji, kar je posebej priročno za otroke in starejše**
- thanks to the reduced height, entering the shower tray is effortless – ideal for children and seniors
- zbog niskog ruba ulazak u tuš kadu je lakši, što je posebno praktično za djecu, starije osobe
- zahvaljujući niskom rubu, ulazak u tuš kadu je olakšan – posebno pogodno za decu, starije osob



- **pokrov sifona je poravnan z višino tuš kadi, kar zagotavlja popolnoma ravno površino in omogoča varno ter nemoteno hojo**
- the siphon cover is aligned with the shower tray height, ensuring a completely flat surface and allowing safe, unobstructed walking
- pokrov sifona poravnan je s visinom tuš kade, što osigurava potpuno ravnu površinu i omogućuje sigurnu, nesmetanu hodnju
- poklopac sifona poravnat je sa visinom tuš kade, što obezbeđuje potpuno ravnu površinu i omogućava sigurnu, nesmetanu hodnju



- **možnost prilagajanja oblike pri določenih modelih**
- possibility of adjusting the shape of certain models
- mogućnost podešavanja oblika određenih modela
- mogućnost prilagođavanja oblika određenih modela



- **4 različne možnosti vgradnje**
- **4** different installation options
- **4** različite mogućnosti ugradnje
- **4** različite mogućnosti postavljanja



- **reliefna površina**
- relief surface
- reliefna površina
- reliefna površina





## Legenda

Legend  
Legenda  
Legenda

048

## Možnosti vgradnje | Installation options | Mogućnosti ugradnje | Mogućnosti ugradnje

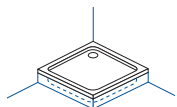

- **tuš kad za postavitev nad nivojem tal**
- shower tray for above-floor installation
- tuš kada za ugradnju iznad razine poda
- tuš kad za ugradnju iznad nivoa poda

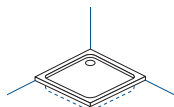

- **tuš kad za postavitev na tla**
- shower tray for installation on the floor
- ugradbena kada za postavljanje na pod
- tuš kada za postavljanje na pod

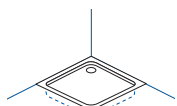

- **tuš kad za vgradnjo v nivoju tal**
- shower tray for installation at the floor level
- ugradbena kada za ugradnju u razini poda
- tuš kada za ugradnju u nivou poda

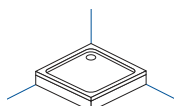

- **tuš kad z oblogo**
- shower tray with panel
- kada za tuširanje s oblogom
- tuš kada s oblogom

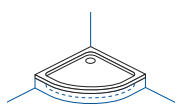

- **polkrožna tuš kad za postavitev nad nivojem tal**
- semi-circular shower tray for above-floor installation
- polukružna tuš kada za ugradnju iznad razine poda
- polukružna tuš kada za ugradnju iznad nivoa poda

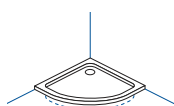

- **polkrožna tuš kad za postavitev na tla**
- semi-circular shower tray for fixing on the floor
- polukružna ugradbena kada za postavljanje na pod
- polukružna tuš kada za postavljanje na pod

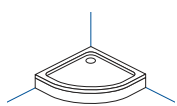

- **polkrožna tuš kad z oblogo**
- semi-circular shower tray with panel
- polukružna kada za tuširanje s oblogom
- polukružna tuš kada s oblogom

## Barve | Colours | Boje | Boje

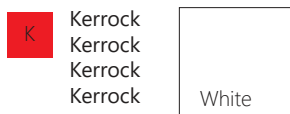

**K** Kerrock  
Kerrock  
Kerrock  
Kerrock

White

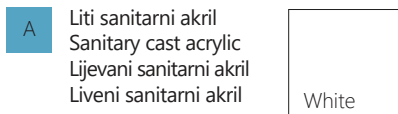

**A** Liti sanitarni akril  
Sanitary cast acrylic  
Lijevani sanitarni akril  
Liveni sanitarni akril

White



**LM** Liti marmor  
Cast marble  
Lijevani mramor  
Liveni mermer

White

Antracit

Manhattan



**MA** Modificirani akril  
Modified acrylic  
Modificirani akril  
Modifikovani akril

White

Graphite



**LLM** Lahki liti marmor  
Lightweight cast marble  
Laki Lijevani mramor  
Laki Liveni mermer

White

Antracit

Manhattan

**new**  
Capuccino

## Opcije | Options | Opcije | Opcije



- **možnosti obrezovanja tuš kadi**
- Shower tray trimming options
- mogućnost rezanja tuš kada po mjeri
- mogućnost rezanja na meru



- **reliefna površina**
- Relief surface
- reljefna površina
- reljefna površina



- **spletni obrazac za obrezovanje tuš kadi**
- Online form for shower tray trimming
- online obrazac za obrezivanje tuš kade
- onlajn obrazac za obradu tuš kade



- **certifikat protizdrsnosti**
- Anti-slip certificate
- certifikat protiv klizanja
- sertifikat protiv klizanja



## Možnosti gradnje tuš kadi

Option of installation of shower trays

Mogućnosti ugradnje tuš kade

Mogućnosti ugradnje tuš kade

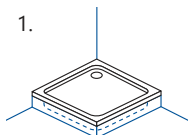
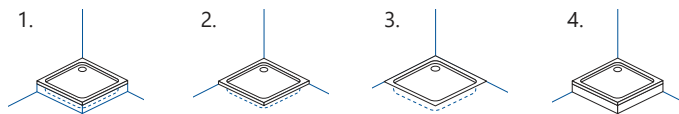

- 1.
- **tuš kad za postavitev nad nivojem tal**
  - shower tray for above-floor installation
  - tuš kada za ugradnjo iznad razine poda
  - tuš kada za ugradnjo iznad nivoa poda

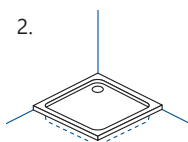

- 2.
- **tuš kad za postavitev na tla**
  - shower tray for fixing on the floor
  - ugradbena kada za postavljanje na pod
  - tuš kada za postavljanje na pod

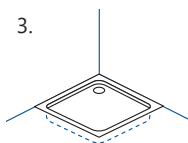

- 3.
- **tuš kad za vgradnjo v nivoju tal**
  - shower tray for installation at the floor level
  - ugradbena kada za ugradnjo u razini poda
  - tuš kada za ugradnjo u nivou poda

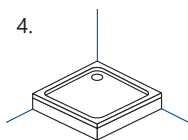

- 4.
- **tuš kad z oblogo**
  - shower tray with panel
  - kada za tuširanje s oblogom
  - tuš kada s oblogom

K	Kerrock	Kerrock	Kerrock	Kerrock
MENORA ZERO				•
MENORA	•	•		
BALLO	•	•	•	
TELLO	•	•	•	

LLM	Lahki liti marmor	Lightweight cast marble	Lagani lijevani mramor	Lagani liveni mermer
HOPP	•	•	•	
HOPP R	•	•		

LM	Liti marmor	Cast marble	Lijevani mramor	Liveni mermer
MOONWALK	•	•	•	
RE-WALK	•	•	•	
TOBAS	•	•	•	
CAPO	•	•	•	
CANARY	•	•	•	
MOONWALK R	•	•		
MACARENA	•	•		•

MA	Modificirani akril	Modified acrylic	Modificirani akril	Modofikovani akril
SERRA	•	•		

A	Liti sanitarni akril	Sanitary cast acrylic	Lijevani sanitarni akril	Liveni sanitarni akril
DROP	•	•		•
DROP R	•	•		•
FLAMENCO	•			•
EVELIN TRAY Q 120X90, 120x80	•	•		•
EVELIN TRAY Q 90X90, 80x80	•	•		•
TRIN	•	•		•
MALUR	•	•		•
EVELIN TRAY R	•	•		•
ONTEX	•	•		•

**K** **Kerrock**  
 Kerrock  
 Kerrock  
 Kerrock

**kerrock**  
 by KOLPA



**MENORA**

200x90 / 200x80 / 180x90 / 180x80 / 160x90  
 160x80 / 140x100 / 140x90 / 140x80 / 120x100  
 120x90 / 120x80 / 100x100 / 100x90 / 100x80  
 90x90 / 90x80 / 80x80



**MENORA ZERO**

200x90 / 200x80 / 180x90 / 180x80 / 160x90  
 160x80 / 140x100 / 140x90 / 140x80 / 120x100  
 120x90 / 120x80 / 100x100 / 100x90 / 100x80  
 90x90 / 90x80 / 80x80



**MENORA R**

100x100 / 90x90

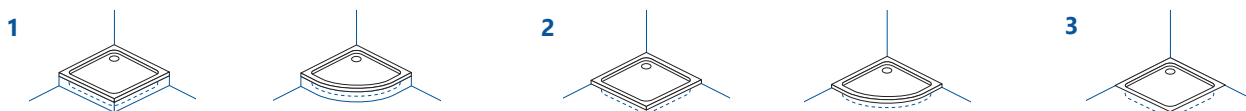

**Vgradnja v nivoju tal, z možnostjo kompenzacije višine do max 15 cm.**

Installation at the floor level with a height compensation option up to 15 cm max.

Ugradnja u razini poda s mogućnošću kompenzacije visine do maks. 15 cm.

Ugradnja u nivou poda, sa mogućnošću kompenzacije visine do maks. 15 cm.

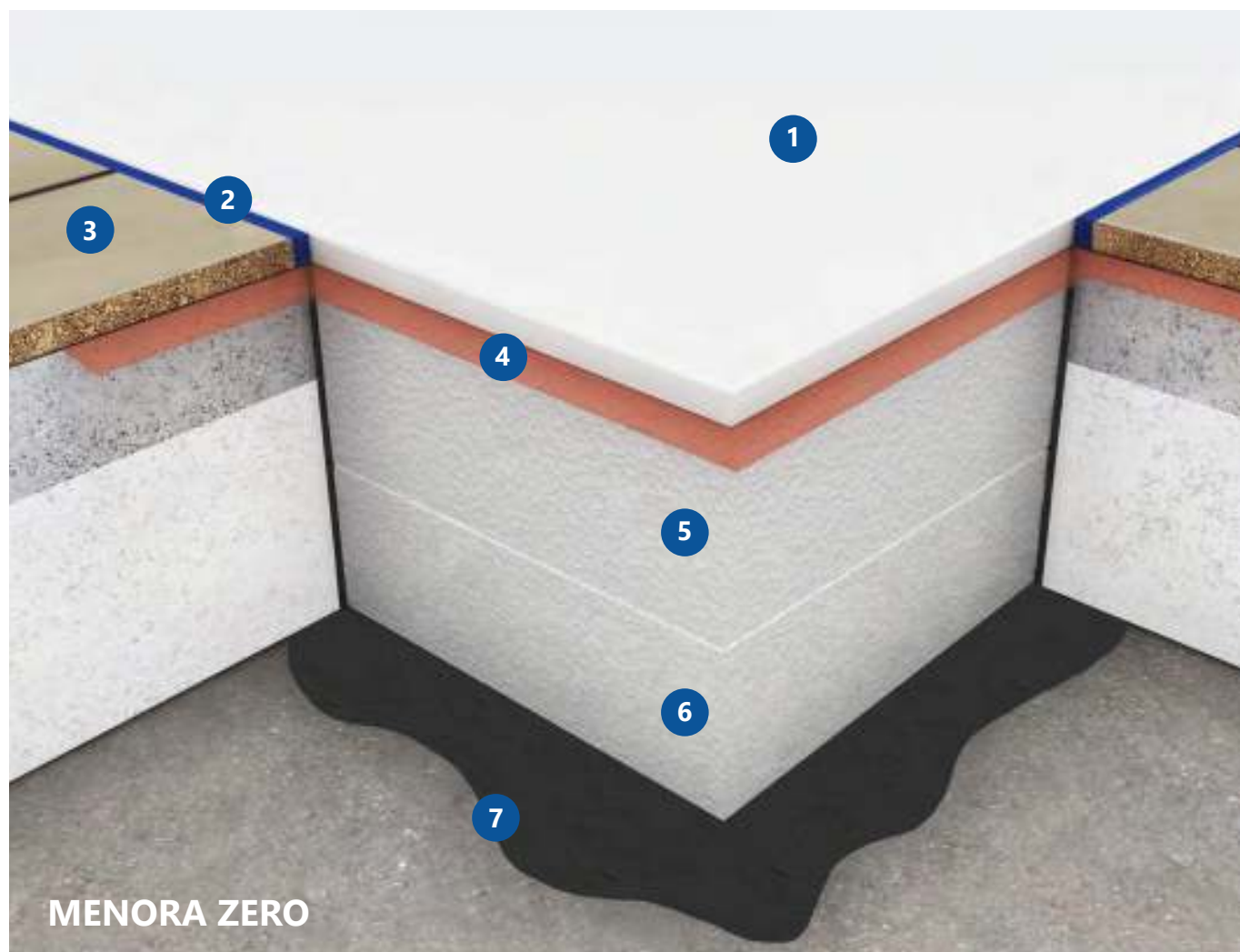

- 1 **Kerrock tuš kad** | Kerrock shower tray | Kerrock tuš kada | Kerrock tuš kada
- 2 **sanitarni silikon** | sanitary silicone | sanitarni silikon | sanitarni silikon
- 3 **keramika** | ceramics | keramika | keramika
- 4 **vodotesna folija** | waterproof foil | vodootporna folija | vodootporna folija
- 5 **stiropor** | polystyrene | stiropor | stiropor – h= 80 mm
- 6 **stiropor** | polystyrene | stiropor | stiropor – h= 50 mm
- 7 **vodotesni premaz** | waterproof coating | vodootporni premaz | vodootporni premaz

**K** **Kerrock**  
 Kerrock  
 Kerrock  
 Kerrock

**kerrock**  
 by KOLPA

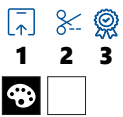

**BALLO**

200x100 / 200x90 / 200x80  
 140x100 / 140x90 / 140x80

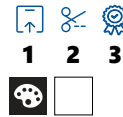

**TELLO**

160x100 / 160x90 / 160x80 / 140x100  
 140x90 / 140x80 / 120x100 / 120x90  
 120x80 / 100x80 / 90x90

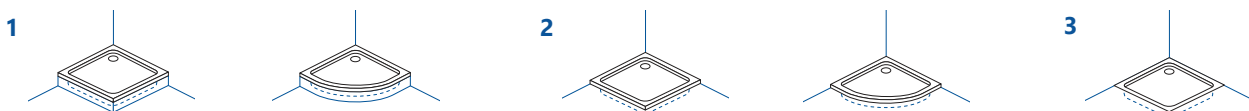



## Tello po meri

Custom made Tello

Tello po mjeri

Tello po meri

**kerrock**  
by KOLPA

053

### Za dimenzije zunaj standardnega razpona ter informacije o dodatnih barvah se obrnite na svojega komercialista.

For dimensions outside the standard range and information on additional colours, please contact your sales representative.

Za dimenzije izvan standardnog raspona i informacije o dodatnim bojama, obratite se svom prodajnom predstavniku.

Za dimenzije van standardnog raspona i informacije o dodatnim bojama, obratite se svom prodajnom predstavniku.



Obrazec Tello po meri

Custom made Tello form

Prilagođeni Tello po mjeri obrazac

Prilagođeni Tello po meri obrazac

### Dimenzija po meri / položaj sifona po meri / oblika po meri

Custom dimension / custom siphon position / custom shape

Prilagođena dimenzija / prilagođeni položaj sifona / prilagođeni oblik

Prilagođena dimenzija / prilagođeni položaj sifona / prilagođeni oblik

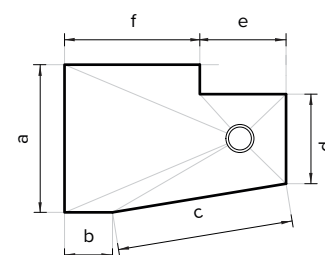
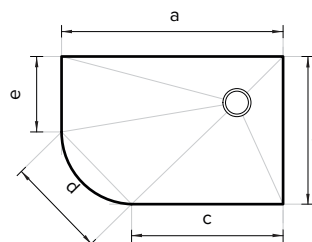
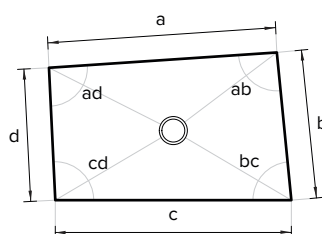
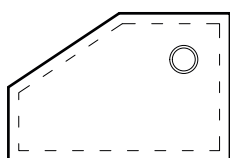

- tuš kad je mogoče popolnoma prilagoditi željam stranke, VENDAR pa mora biti sifon oddaljen najmanj 20 cm od roba tuš kadi
- shower tray can be fully custom-made BUT the siphon must be a minimum of 20cm from the edge of the shower tray
- tuš kada se može u potpunosti prilagoditi željama kupca, ALI sifon mora biti udaljen najmanje 20 cm od ruba tuš kade
- tuš kadu je moguće potpuno prilagoditi željama kupca, ALI sifon mora biti udaljen najmanje 20 cm od ivice tuš kade.

# LLM

## Lahki liti marmor

Lightweight cast marble

Lagani lijevani mramor

Lagani liveni mermer

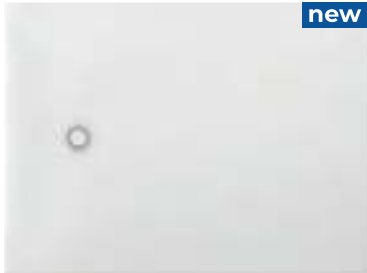

1 2 3

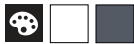

### HOPP

200x90 / 200x80 / 180x90  
180x80 / 160x90 / 160x80 / 140x100  
140x90 / 140x80 / 140x70 / 120x100  
120x90 / 120x80 / 120x70 / 100x100  
100x90 / 100x80 / 90x90 / 90x80  
90x70 / 80x80



1 2 3



### HOPP R

100x100 / 90x90

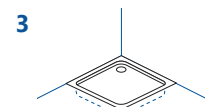
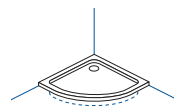
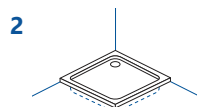
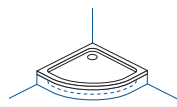
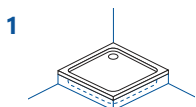



# LM

**Liti marmor**  
Cast marble  
Lijevani mramor  
Liveni mermer

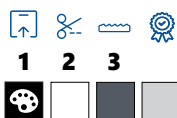

## MOONWALK

140x90 / 140x80 / 120x90  
120x80 / 100x100 / 100x90  
100x80 / 90x90



## MOONWALK R

100x100 / 90x90

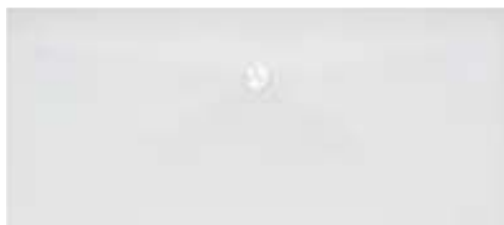

## RE-WALK

180x80 / 140x90 / 140x80



## TOBAS

140x90 / 140x80 / 120x90  
120x80 / 100x90 / 100x80 / 90x90



## CAPO

140x100 / 140x90 / 120x90  
120x80 / 100x80 / 90x90

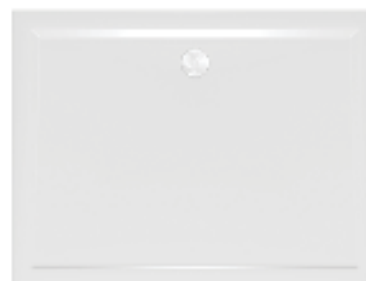

## CANARY

120x90 / 120x80 / 100x80  
90x90 / 80x80

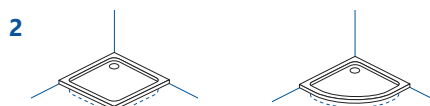
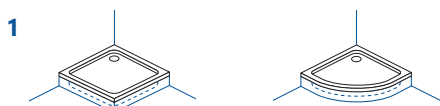

# LM

**Liti marmor**  
Cast marble  
Lijevani mramor  
Liveni mermer



# MA

**Modificirani akril**  
Modified acrylic  
Modificirani akril  
Modifikovani akril

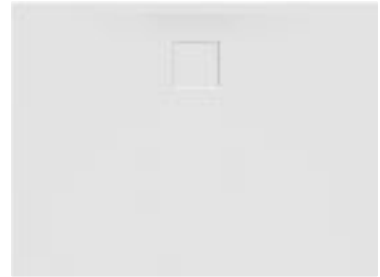

**MACARENA**  
100x100 / 90x90



**SERRA**  
120x90 / 90x90

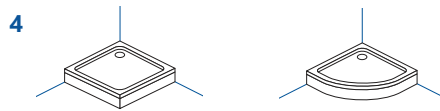
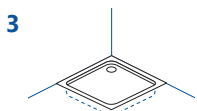

# A

## Liti sanitarni akril

Sanitary cast acrylic  
Sanitarni ljevani akril  
Sanitarni liveni akril



### DROP

140x90 / 140x80 / 120x90 / 120x80  
100x90 / 100x80 / 90x90 / 80x80



### DROP R

90x90 / 80x80

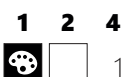

### FLAMENCO

180x80 / 170x80 / 170x75 / 160x90 / 160x80 / 160x70  
140x90 / 140x80 / 140x70 / 130x90 / 130x80 / 120x100  
120x90 / 120x80 / 120x70 / 110x90 / 110x80 / 100x100 / 100x90  
100x80 / 90x90 / 90x80 / 90x70 / 80x80 / 70x70

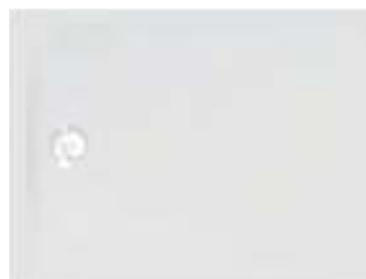

### EVELIN TRAY

120x90 / 120x80



### EVELIN TRAY Q

90x90 / 80x80



### TRIN

90x90 / 80x80

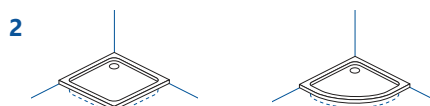
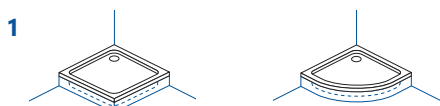



**MALUR - L**  
120x90 / 100x80



**MALUR - D**  
120x90 / 100x80



**EVELIN TRAY R**  
90x90 / 80x80



**ONTEX**  
90x90 / 80x80

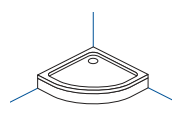
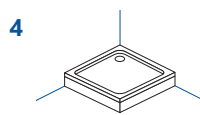
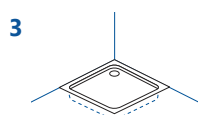



## Možnosti obrezovanja tuš kadi

Shower tray trimming options

Mogućnost rezanja tuš kada po mjeri

Mogućnost rezanja tuš kada po meri

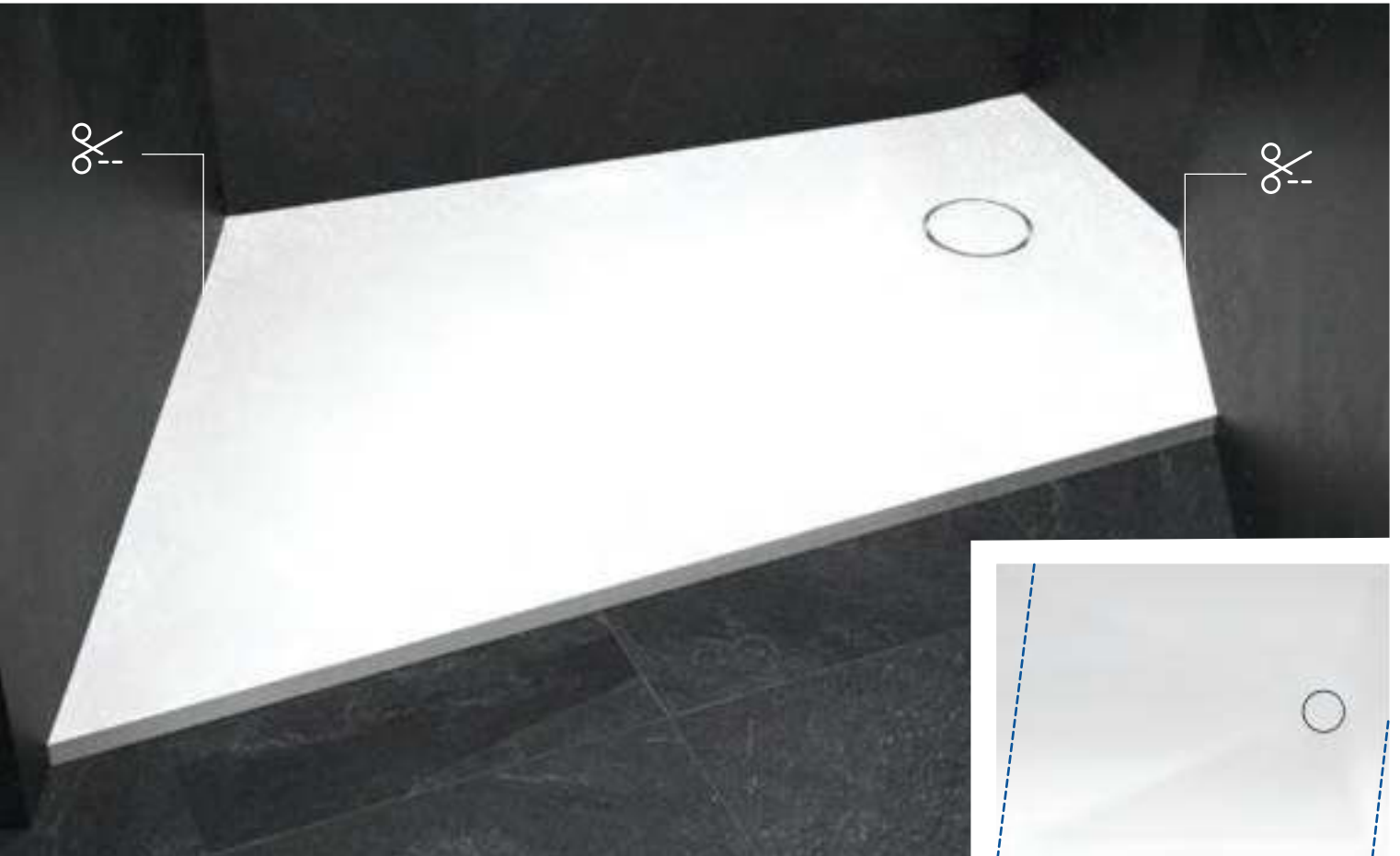

### Obrezovanje tuš kadi

Za primere, ko arhitekturne lastosti kopalnic, zlasti pri obnovah starejših objektov, ne dovoljujejo vgradnje klasičnih tuš kadi iz rednega programa, nudimo našim strankam možnost prilagoditve določenih tuš kadi njenim specifičnim zahtevam. Za dodatne informacije glede modelov in možnosti, obiščite našo spletno stran [www.kolpasan.si](http://www.kolpasan.si)

### Shower tray trimming

For situations where the architectural properties of bathrooms, especially in the renovation of older buildings, do not allow the installation of classic shower trays from the regular program, we provide our customers with the opportunity of adapting certain shower trays to their specific requirements. For further information on the models and options, please visit our website [www.kolpasan.si](http://www.kolpasan.si)

### Rezanje tuš kada po mjeri

Za slučajeve kada arhitektonska svojstva kupaonica, posebno prilikom renoviranja starijih objekata, ne dopuštaju ugradnju klasičnih tuš kada iz redovnog programa, našim kupcima pružamo mogućnost prilagodbe određenih tuš kada njihovim specifičnim zahtjevima. Za dodatne informacije o modelima i mogućnostima posjetite našu internetsku stranicu [www.kolpasan.si](http://www.kolpasan.si)

### Mogućnost rezanja tuš kada po meri

Za slučajeve kada arhitektonske karakteristike kupatila, posebno pri renoviranju starijih objekata, ne dozvoljavaju postavljanje klasičnih tuš-kada iz redovnog programa, našim klijentima nudimo mogućnost prilagođavanja određenih tuš-kada njihovim specifičnim zahtevima. Za dodatne informacije o modelima i mogućnostima posetite našu internet stranicu [www.kolpasan.si](http://www.kolpasan.si)



## Možnosti obrezovanja tuš kadi

Showers tray trimming options

Mogućnost rezanja tuš kada po mjeri

Mogućnost rezanja tuš kada po meri

061

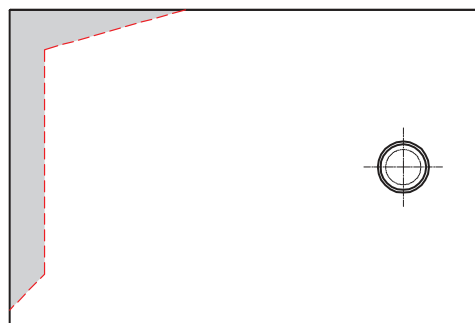
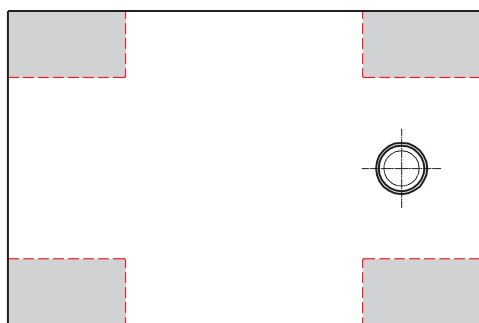
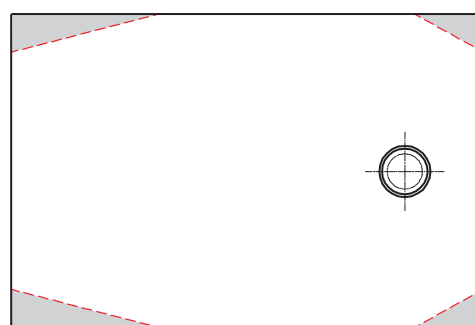
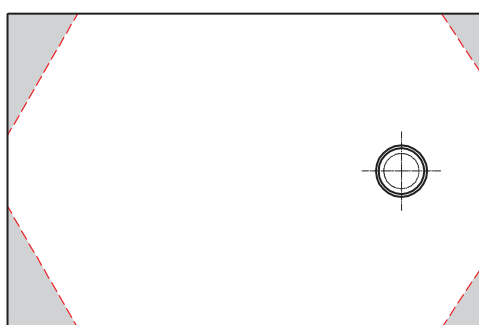
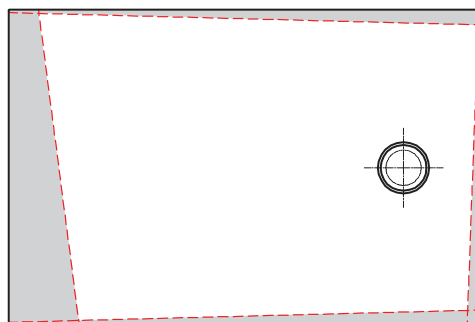
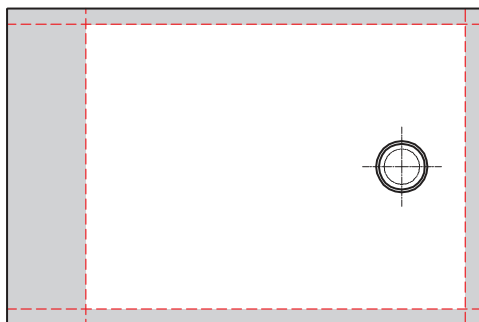

### Vzorec obrazca za obrezovanje tuš kadi

Na voljo so različne izvedbe obrezovanja pri tuš kadeh Ballo, Tello, Hopp, Moonwalk, Re-walk. Za dotični obrazec, obiščite našo spletno stran [www.kolpasan.si](http://www.kolpasan.si)

### Sample of shower tray trimming form

Various trimming options are available for Ballo, Tello, Hopp, Moonwalk, Re-walk. For the form in question, please visit our website [www.kolpasan.eu](http://www.kolpasan.eu)

### Primjerak obrasca za rezanje po mjeri tuš kada

Na raspolaganju su različite verzije rezanja tuš kada Ballo, Tello, Hopp, Moonwalk, Re-walk. Za navedeni obrazac posjetite našu internetsku stranicu [www.kolpasan.hr](http://www.kolpasan.hr)

### Primer rezanja tuš kada po meri

Na raspolaganju su različite verzije rezanja tuš kada Ballo, Tello, Hopp, Moonwalk, Re-walk. Za navedeni obrazac, posetite našu internet stranicu [www.kolpasan.rs](http://www.kolpasan.rs)





# 04

## Dinamika tuš kabine

Za tuš kabino se odločamo zaradi hitrega tempa življenja, pomanjkanja prostora, manjše porabe vode in manjšega odtisa na okolje. Tuš kabine Kolpasan nam pomagajo kopalnico prostorsko čimbolje izkoristiti, optično povečati, pa tudi vsakodnevno lažje čistiti.

**Tuš kabine**  
Shower enclosures  
Tuš kabine  
Tuš kabine

## Dynamics of shower enclosure

We opt for a shower enclosure due to the fast pace of life, lack of space, lower water consumption and lower footprint on the environment. Kolpasan shower enclosures help us make the most of the bathroom, optically enlarge it, and facilitate daily cleaning.

## Dinamika tuš kabine

Za tuš kabinu se odlučujemo zbog brzog tempa života, manjka prostora, manje potrošnje vode i manjeg utjecaja na okoliš. Tuš kabine Kolpasan pomažu nam da što bolje iskoristimo svoju kupaonice, optički je povećamo i olakšamo svakodnevno čišćenje.

## Dinamika tuš kabine

Za tuš-kabinu se odlučujemo zbog brzog tempa života, nedovoljno prostora, manje potrošnje vode i manjeg uticaja na okolinu. Tuš-kabine Kolpasan nam pomažu da što bolje iskoristimo svoje kupatilo, da ga optički povećamo i olakšamo svakodnevno čišćenje.





# 04

064



# TUŠ KABINE / SHOWER ENCLOSURES

## TUŠ KABINE / TUŠ KABINE



- **možnosti izbire med različnimi vrstami stekel in profilov**
- select between different types of glass and profiles
- možnost izbora između različnih vrsta stakla i profila
- možnost odabira između različnih vrsta stakla i profila



- **sodobno oblikovane tuš kabine čistih oblik z robustno konstrukcijo**
- modern designed shower enclosures with pure geometric shapes
- moderno dizajnirane tuš kabine čistih oblik s robustno konstrukcijom
- moderan dizajn tuš-kabine sa čistim oblikom i čvrstom konstrukcijom



- **naši izdelki omogočajo različne možnosti vgradnje**
- our products offer different options of installation
- naši proizvodi omogočuju različite možnosti ugradnje
- naši proizvodi omogućavaju različite možnosti postavljanja

10

- **več kot 10 družin tuš kabin za opremo najrazličnejših vrst kopalnic**
- more than **10** models of shower enclosures for the equipment of a wide range of bathrooms
- više od **10** modela tuš kabina za opremo raznih vrsta kupaonica
- više od **10** modela tuš kabina za opremanje različnih vrsta kupatila



- **možnost prilagajanja oblike pri določenih modelih**
- possibility of adjusting the shape at certain models
- možnost prilagođavanja oblika određenih modela
- možnost prilagođavanja oblika određenih modela



- **možnost izvedbe nestandardni dimenzij z dodatnimi kompenzacijskimi profili**
- possibility of implementing non-standard dimensions with additional compensation profiles
- možnost izvedbe nestandardnih dimenzija s dodatnim kompenzacijskim profilima
- možnost izvođenja nestandardnih dimenzija sa dodatnim kompenzacionim profilima





**Legenda**  
Legend  
Legenda  
Legenda

066

**Vrste tuš kabin** | Types of shower enclosures | Vrste tuš kabina | Vrste tuš kabina

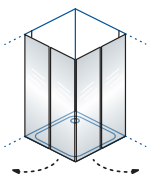

- Q**
- **kvadratna, krilna**
  - square, winged
  - kvadratna, klizna
  - kvadratna, spoljašnje otvaranje vrata

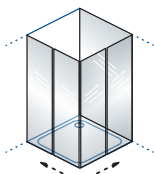

- Q | TKK**
- **kvadratna, drsna**
  - square, sliding
  - kvadratna, klizna
  - kvadratna, klizna

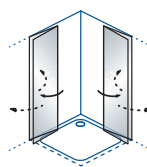

- Q**
- **kvadratna, zložljiva**
  - square, folding
  - kvadratna, sklopiva
  - kvadratna, sklopiva

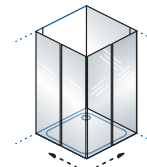

- D+ D + WU**
- **kvadratna, drsna, + stena**
  - square, sliding + wall
  - kvadratna, klizna + stijena
  - kvadratna, klizna + stena

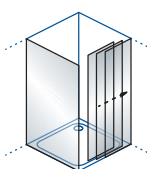

- TV3D/S + TSv**
- **drsna vrata + stena**
  - sliding door + wall
  - klizna vrata + stijena
  - klizna vrata + stena

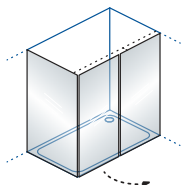

- D + W**
- **krilna vrata + stena**
  - winged door + wall
  - krilata vrata + stijena
  - krilata vrata + stena

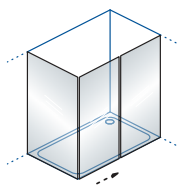

- D + W | DW | TK**
- **drsna vrata + stena**
  - sliding door + wall
  - klizna vrata + stijena
  - klizna vrata + stena

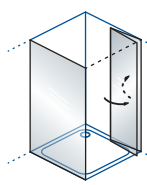

- D + W | TVZ/S + TSvZ**
- **zložljiva vrata + stena**
  - folding door + wall
  - zložljiva vrata + stijena
  - sklopiva vrata + stena

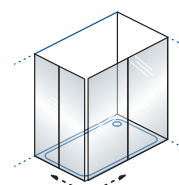

- D + D**
- **vrata + vrata, drsna**
  - door + door, sliding
  - vrata + vrata, klizna
  - vrata + vrata, klizna

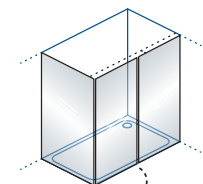

- DW**
- **drsna rotirajuća vrata + stena**
  - sliding-rotating door + wall
  - klizna-rotirajuća vrata + stijena
  - klizna-rotirajuća vrata + stena

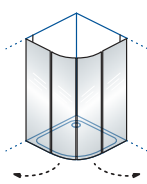

- R**
- **polkrožna, krilna**
  - semi-circular, winged
  - polukružna, krilata
  - polukružna, spoljašnje otvaranje vrata

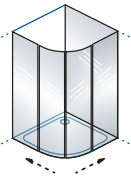

- R | TKP**
- **polkrožna, drsna**
  - semi-circular, sliding
  - polukružna, klizna
  - polukružna, klizna

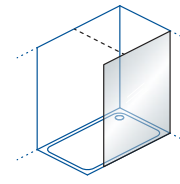

- WO**
- **tuš stena - open**
  - shower wall - open
  - tuš stijena - open
  - tuš stena - open

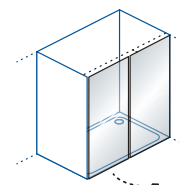

- N**
- **niša, krilna**
  - niche, winged
  - niša, krilata
  - niša, spoljašnje otvaranje vrata

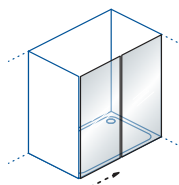

- N | TV2D/S**
- **niša, drsna**
  - niche, sliding
  - niša, klizna
  - niša, klizna

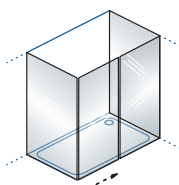

- N + 2x WU**
- **niša, drsna + 2 steni**
  - niche, sliding + 2 walls
  - niša, klizna + 2 stijene
  - - niša, klizna + 2 stene

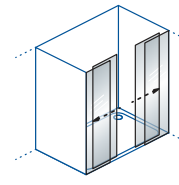

- N (TV/S)**
- **niša, 4 delna, drsna**
  - niche, 4 part, sliding
  - niša, 4 dijelna, klizna
  - niša, 4 delna, klizna

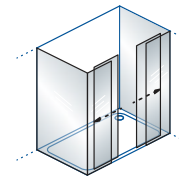

- N + 2x WU**
- **niša, 4 delna, drsna + 2 steni**
  - niche, 4 part, sliding + 2 walls
  - niša, 4 dijelna, klizna + 2 stijene
  - niša, 4 delna, klizna + 2 stene

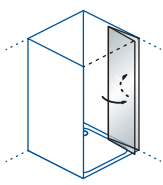

- N**
- **niša, zložljiva**
  - niche, folding
  - niša, zložljiva
  - niša, sklopiva

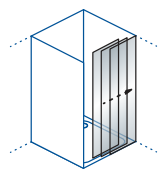

- TV3D/S**
- **niša, drsna**
  - niche, sliding
  - niša, klizna
  - niša, klizna

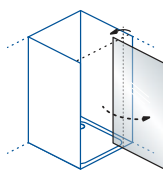

- TVO/S**
- **niša, obračalna**
  - niche, turnable
  - niša, okretljiva
  - niša, okretna

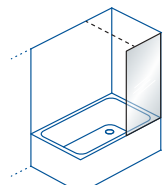

- BS (TP)**
- **krilni zaslon**
  - bathtub screen
  - paravan
  - paravan

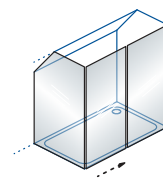

- **po meri**
- custom made
- po narudžbi
- po meri



## Legenda

Legend  
Legenda  
Legenda

### Barva profila | Profile colour | Boja profila | Boja profila



**Gold (GLD)**  
Gold (GLD)  
Gold (GLD)  
Gold (GLD)



**Silver Brill (SBR)**  
Silver Brill (SBR)  
Silver Brill (SBR)  
Silver Brill (SBR)



**Black (B)**  
Black (B)  
Black (B)  
Black (B)



**Silver (S)**  
Silver (S)  
Silver (S)  
Silver (S)



**Bela (WH)**  
White (WH)  
Bijela (WH)  
Bela (WH)



**debelina stekla**  
glass thickness  
debljina stakla  
debljina stakla



**višina profilov**  
height of profiles  
visina profila  
visina profila

### Vrste stekla | Types of glass | Vrste stakla | Vrste stakla

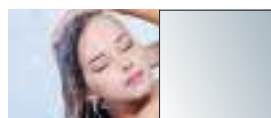

**kaljeno prozorno steklo (1)**  
tempered transparent glass  
kaljeno prozirno staklo  
kaljeno providno staklo



**kaljeno chincilla steklo (2)**  
tempered chinchilla glass  
kaljeno chincilla staklo  
kaljeno chincilla staklo

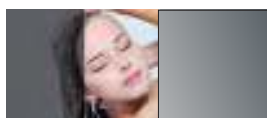

**graphite kaljeno steklo (3)**  
graphite tempered glass  
graphite kaljeno staklo  
graphite kaljeno staklo

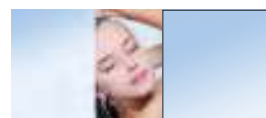

**mirror steklo (5)**  
mirror glass  
mirror staklo  
mirror staklo

### Opcije | Options | Opcije | Opcije



- **zapiranje z magnetnim profilom**
- magnetic edge closure
- zatvaranje s magnetnim profilom
- zatvaranje pomoću magnetnog profila



- **tečaji z dvizno funkcijo**
- hinges with lifting function
- okovi s podiznim profilom
- šarke sa funkcijom podizanja



- **Clean coat, zaščitni premaz**
- Clean coat, protective coating
- Clean coat, zaštitni premaz
- Clean coat, zaštitni premaz



- **dodatni aluminijasti profil na tuš kadi preprečuje iztekanje vode**
- an additional aluminium edge on the shower tray prevents overflow
- dodatni aluminijasti profil na tuš kadi sprječava istjecanje vode
- dodatni aluminijasti profil na tuš kadi sprečava izlivanje vode



- **snemljiva vratna krila omogočajo lažje čiščenje**
- detachable door panels for easier cleaning
- vratna krila na skidanje omogočuju lakše čiščenje
- vratna krila sa mogućnošću skidanja omogućavaju lakše čiščenje



- **demontažni pokrov**
- demounting cover
- demontažni poklopac
- demontažni poklopac



- **drsno-rotirajuća vrata, omogočajo veliko vhodno odprtino**
- sliding-rotating doors, allowing a large entrance opening
- klizna-rotirajuća vrata, omogućujući veliki ulazni otvor
- klizna-rotirajuća vrata, omogućava veliki ulazni otvor



- **možnost kompenzacijskih profilov**
- the possibility of compensation profiles
- mogućnost kompenzacijskih profila
- mogućnost kompenzacionih profila



- **držalo za brisače**
- towel holder
- držač ručnika
- držač za peškire



- **opora za stabilnost tuš kabine**
- support for the stability of the shower enclosure
- potpora za stabilnost tuš kabine
- oslonac za stabilnost tuš kabine



- **mirror steklo (8 mm)**
- mirror glass (8 mm)
- mirror staklo (8 mm)
- mirror staklo (8 mm)

### Faktorji vodotesnosti tuš kabin po modelih | Factors affecting water tightness of shower cabins according to models

Čimbenici vodonepropusnosti tuš kabina po modelima | Faktori koji utiču na vodonepropusnost tuš kabina u zavisnosti od modela



**Faktorji vodotesnosti tuš kabin po modelih**  
Factors affecting water tightness of shower cabins according to models  
Čimbenici vodonepropusnosti tuš kabina po modelima  
Faktori koji utiču na vodonepropusnost tuš kabina u zavisnosti od modela



**Dodatni zaščitni profil**  
Additional protection profiles  
Dodatni zaštitni profil  
Dodatni zaštitni profil



**Kabine s spodnjim okvirjem**  
Enclosures with the bottom frame  
Kabine s donjim okvirom  
Kabine sa donjim okvirom



**Kabine brez okvirja**  
Enclosures without a frame  
Kabine bez okvira  
Kabine bez okvira



# POLARIS

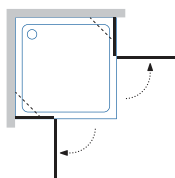

**Q 100, 90, 80**

100x100 / 90x90 / 80x80

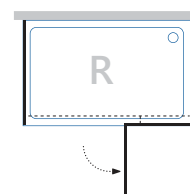
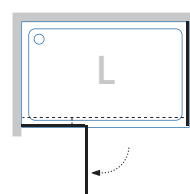
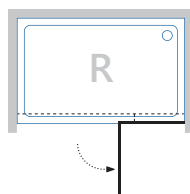
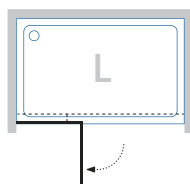

**N 140, 120, 100, 90**

140 / 120 / 100 / 90

**D 140, 120, 100, 90, 80**

140 / 120 / 100 / 90

**+ W 100, 90, 80**

100 / 90 / 80

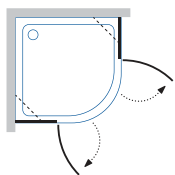

**R 100, 90**

100x100 / 90x90



8/6 mm

2000 mm

2000 mm



8 mm



6 mm



2000 mm



# POLARIS FOLD

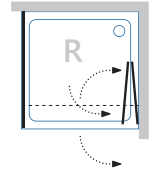
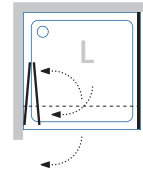
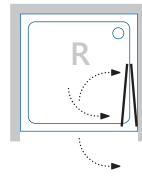
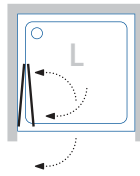
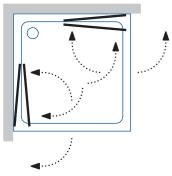

**Q 100, 90, 80**

100x100 / 90x90 / 80x80

**N 100, 90, 80**

100 / 90 / 80

**D 100, 90, 80**

100 / 90 / 80

**+ W 100, 90, 80**

100 / 90 / 80



6/6 mm



2000 mm



2000 mm





8 mm



6 mm



2000 mm



# ANDROMEDA UNI

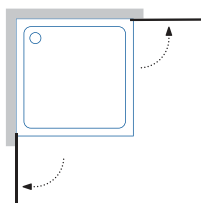

**Q 100, 90, 80**

100x100 / 90x90 / 80x80

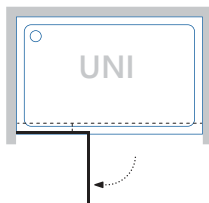

**N 160, 140, 120**

160 / 140 / 120

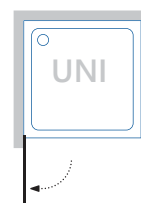

**N 100, 90, 80**

100 / 90 / 80

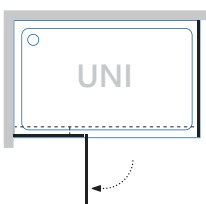

**D 160, 140, 120**

160 / 140 / 120

**+ W 100, 90, 80**

100 / 90 / 80

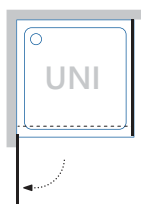

**D 100, 90, 80**

100 / 90 / 80

**+ W 100, 90, 80**

100 / 90 / 80



8/6 mm



2000 mm



2000 mm



2000 mm



5 years



2000 mm



2000 mm



2000 mm



2000 mm

074



2000 mm



6 mm



# AQUARIUS UNI



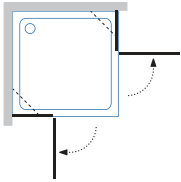

**Q 90**  
90x90

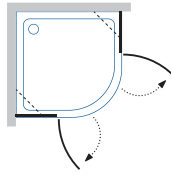

**R 90**  
90x90

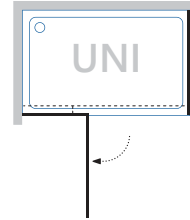

**D 120, 100, 90**  
120 / 100 / 90  
**+ W 90, 80**  
90 / 80

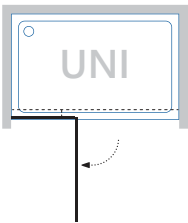

**N 120, 100, 90**  
120 / 100 / 90



6 mm

2000 mm

2000 mm

076



2000 mm

8 mm

# CALYPSO UNI



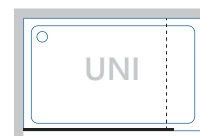

**WO 140, 120, 100**

140 / 120 / 100































 Black (B)  
Black (B)  
Black (B)  
Black (B)

 GOLD (zlati) profili, brušen  
GOLD profiles, grinded  
GOLD (zlatni) profili, uglađen  
GOLD (zlatni) profili, uglačan

 Srebrna Brill (SBR)  
Silver Brill (SBR)  
Srebrna Brill (SBR)  
Srebrna Brill (SBR)

PROFILI / PROFILES

STEKLO / GLASS

WO 140-UNI GOLD CALYPSO				
WO 120-UNI GOLD CALYPSO				
WO 100-UNI GOLD CALYPSO				
WO 140-UNI B CALYPSO				
WO 120-UNI B CALYPSO				
WO 100-UNI B CALYPSO				
WO 140-UNI SBR CALYPSO				
WO 120-UNI SBR CALYPSO				
WO 100-UNI SBR CALYPSO				

 Kaljeno prozorno steklo (1)  
Tempered transparent glass (1)  
Kajjeno prozorno staklo (1)  
Kajjeno providno staklo (1)

 Graphite kajjeno steklo (3)  
Graphite tempered glass (3)  
Graphite kajjeno staklo (3)  
Graphite kajjeno staklo (3)

 Mirror steklo (5)  
Mirror glass (5)  
Mirror staklo (5)  
Mirror staklo (5)

 Clean coat, zaščitni premaz  
Clean coat, protective coating  
Clean coat, zaščitni premaz  
Clean coat, zaščitni premaz





8 mm



2000 mm



8 mm



**LIBRA**

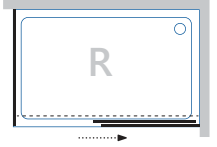
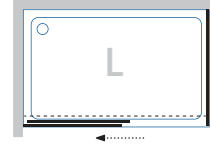
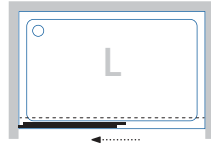
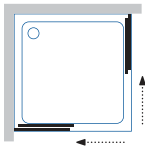

**Q 100, 90**

100x100 / 90x90

**N 140, 120, 100 - L, R**

140 / 120 / 100

**DW 140, 120, 100 - L, R**

140x90 / 140x80 / 120x100 / 120x90  
120x80 / 100x100 / 100x90 / 100x80

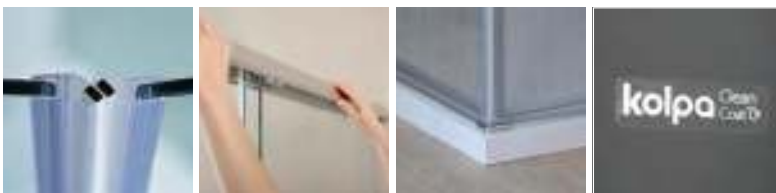



—

8 mm



8 mm



—



—



—



—



—



2000 mm

# VIRGO UNI

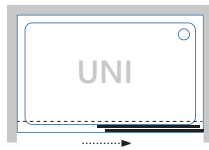
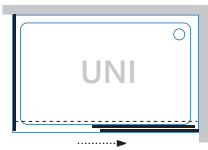

**TK 160, 140, 120**

160x90 / 160x80 / 140x90  
140x80 / 120x90 / 120x80

**TV2D/S 160, 140, 120**

160 / 140 / 120

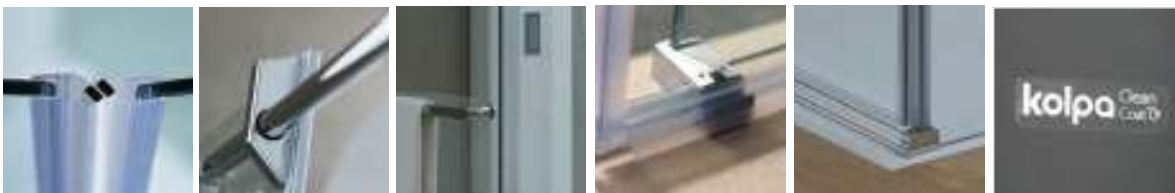



6 mm



2000 mm



# STELLAR UNI

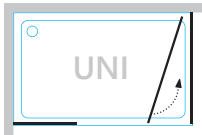

**DW 120, 90**

120x90 / 120x80 / 90x90

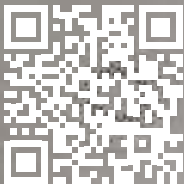

Video odpiranja kabine  
Video of the shower enclosure opening  
Video otvaranja kabine  
Video otvaranja kabine



1.



2.



3.

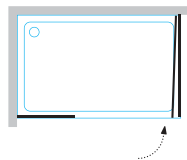
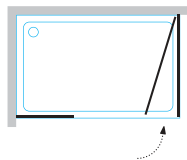
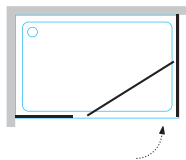
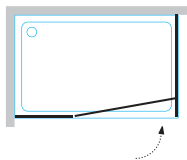
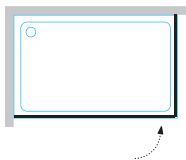

6 mm



2000 mm



2000 mm





6 mm

2000 mm



# VENUS UNI

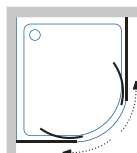
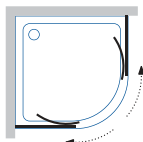
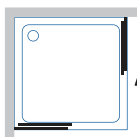

**Q 90, 80**

90x90 / 80x80

**R 120, 100, 90, 80**

120x90 / 100x100 / 100x80  
90x90 / 80x80

**D 170, 160, 140, 120, 110, 100, 90, 80, 70**

170 / 160 / 140 / 120 / 110 / 100 / 90 / 80 / 70  
**+ D 170, 160, 140, 120, 110, 100, 90, 80, 70**  
170 / 160 / 140 / 120 / 110 / 100 / 90 / 80 / 70

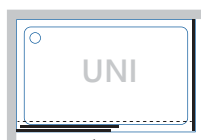

**D 170, 160, 140, 120, 110, 100**

170 / 160 / 140 / 120 / 110 / 100  
**+ W 100, 90, 80, 70**  
100 / 90 / 80 / 70

**N\* 170, 160, 140**

170 / 160 / 140

**N 120, 110, 100**

120 / 110 / 100

**\* 4 delna** | 4 part | 4 dijelna | 4 delna



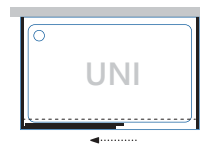
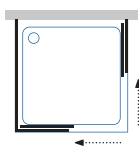

**D 90, 80, 70**

90 / 80 / 70

**+ D 170, 160, 140, 120, 110, 100, 90**

170 / 160 / 140 120 / 110 / 100 / 90

**+ WU 90, 80, 70**

90 / 80 / 70

**N\* 170, 160, 140**

170 / 160 / 140

**+ 2xWU 90, 80, 70**

90 / 80 / 70

**\* 4 delna | 4 part | 4 dijelna | 4 delna**

**N 120, 110, 100**

120 / 110 / 100

**+ 2xWU 90, 80, 70**

90 / 80 / 70







4 mm



1900 mm  
1850 mm



# LUNA UNI



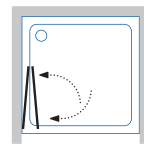
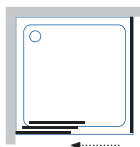
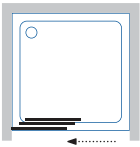

**TV3D/S 100, 90, 80**

100 / 90 / 80

**TV3D/S 100, 90, 80**

100 / 90 / 80

**TSv3D 90, 80**

90 / 80

**TVZ/S 90, 80**

90 / 80

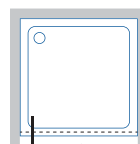
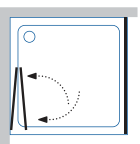

**TVZ/S 90, 80**

90 / 80

**+ TSvZ 90, 80**

90 / 80

**TVO/S 90, 80**

90 / 80



090



5 mm

1850 mm



# ECO QUAT



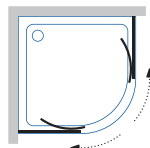
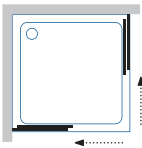

**TKK 90, 80**

90x90 / 80x80

**TKP 90, 80**

90x90 / 80x80



5 mm



1850 mm



1850 mm



+



-



+



-



+



-



+



-



+



-



+



-



8 mm



1400 mm

# POLARIS UNI



### BS 80 UNI 1

80

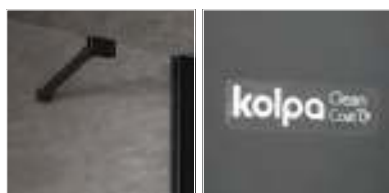

8 mm



1400 mm



1400 mm



4



6 mm



8 mm

1400 mm



# ANDROMEDA UNI

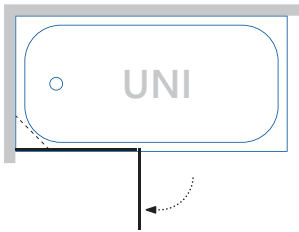

**BS 120 UNI 1-2P**  
120

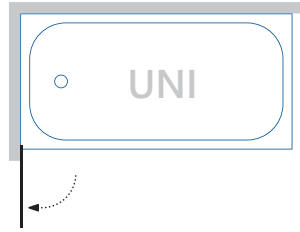

**BS 80 UNI 1-1P**  
80

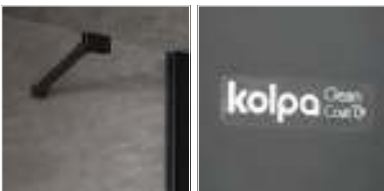

6/8 mm

1400 mm

1400 mm





6 mm



1400 mm

**SOLE UNI**

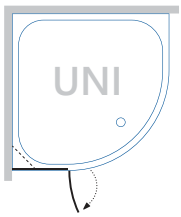

**TP 104 UNI**  
104

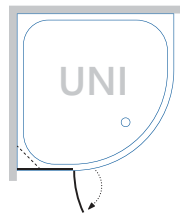

**TP 102 UNI**  
102



6 mm

1400 mm

098



5 mm



1400 mm

**QUAT UNI**

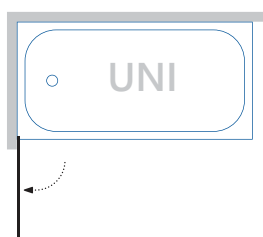

**TP 80 UNI**

80



6 mm

1400 mm





## Dodatni profili pri tuš kabinah

Additional profiles for shower enclosures

Dodatni profili za tuš kabine

Dodatni profili kod tuš kabina



### Imam nestandardne dimenzije kopalnice, kaj pa zdaj?

The dimensions of my bathroom are non-standard. What now?

Imam nestandardne dimenzije kupaonice, što sada?

Imam nestandardne dimenzije kupatila, šta da radim?

Za primere, ko prostor na razpolago za vgradnjo tuš kabin ni standardnih dimenzij, smo razvili dodatne kompenzacijske profile, s katerimi lahko prilagodimo standardne izdelke na željeno mero. Pri posameznih družinah tuš kabin lahko preverite, kateri izdelki ponujajo to možnost.

For the situations where the space available for the installation of a shower enclosure is of non-standard size, we have designed additional compensation studs allowing adjusting standard products to the desired dimensions. Verify compatible products for individual shower enclosure dimensions.

Za slučajeve kada prostor na raspolaganje za ugradnju tuš kabina nije standardnih dimenzija razvili smo dodatne kompenzacijske profile s kojima možemo prilagoditi standardne proizvode prema željenoj mjeri. Kod pojedinih duljina tuš kabina možete provjeriti koji proizvodi pružaju tu mogućnost.

Za slučajeve, kad prostor za ugradnju tuš kabina nije standardnih dimenzija, razvili smo dodatne kompenzacione profile pomoću kojih možemo da prilagodimo standardne proizvode na željenu meru. Kod pojedinih dužina tuš kabina možete proveriti koji proizvodi pružaju tu opciju.

### Primer uporabe dodatnega profila

Example of using an additional profile

Primjer uporabe dodatnoga profila

Primer korišćenja dodatnog profila

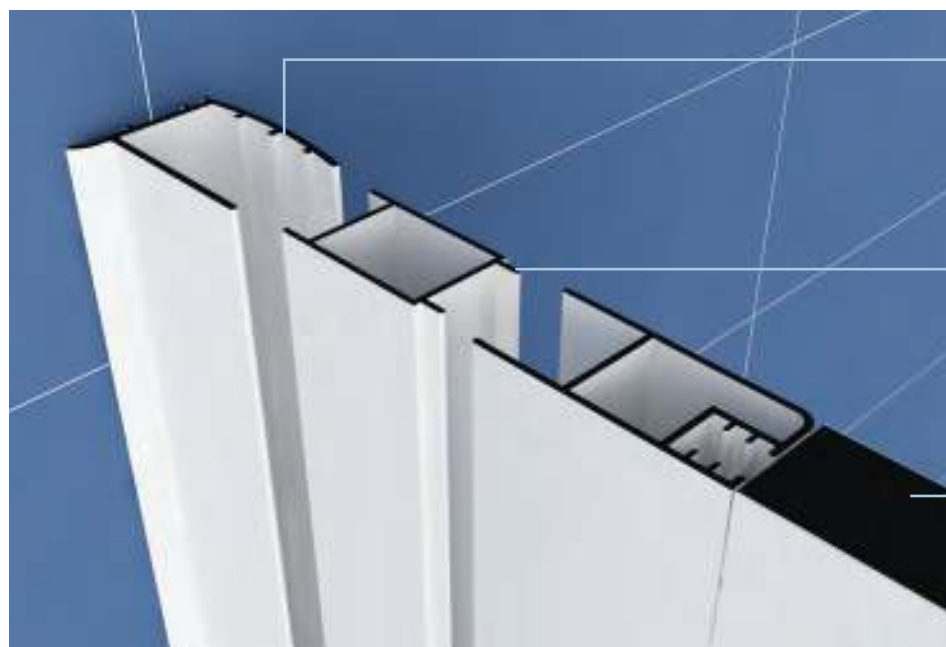

#### zidni profil

wall profile  
zidni profil  
zidni profil

#### dodatni kompenzacijski profil

additional compensation profile  
dodatni kompenzacijski profil  
dodatni kompenzacioni profil

#### tuš vrata

shower enclosures  
tuš vrata  
tuš vrata



## Tuš kabine posebnih dimenzij

Shower cabins with special dimensions

Tuš kabine posebnih dimenzija

Tuš kabine posebnih dimenzija



### Kaj pa če v rednem programu ni rešitve za mojo tuš kabino?

What if I don't find a solution for my shower enclosure in your regular programme?

A što ako u redovnom programu nema rješenja za moju tuš kabinu?

Šta ako u redovnom programu nema rešenja za moju tuš kabinu?

V primeru, da vam naše standardne rešitve tuš kabin ne pridejo prav, vam lahko izdelamo rešitev po meri. Za več informacij o tuš kabinah posebnih dimenzij obiščite spletno stran [www.kolpa.si](http://www.kolpa.si).

In case our standard solutions of shower enclosures fail to meet your requirements, we can design a tailor-made solution for you. For more information on non-standard shower cabins/enclosures, visit our [www.kolpa.si](http://www.kolpa.si) website.

U slučaju da vam naša standardna rješenja tuš kabina ne odgovaraju, možemo vam izraditi rješenje po mjeri. Za više informacija o tuš kabinama posebnih dimenzija posjetite internetsku stranicu [www.kolpa.si](http://www.kolpa.si).

U slučaju da vam naša standardna rešenja tuš kabina ne odgovaraju, možemo vam izraditi rešenje po meri. Za više informacija o tuš kabinama posebnih dimenzija posetite internet stranu [www.kolpa.si](http://www.kolpa.si).



#### Možnost prilagoditve višine

Height adjustment option

Mogućnost prilagodbe visine

Mogućnost prilagođavanja visine



#### Možnost prilagoditve širine

Width adjustment option

Mogućnost prilagodbe širine

Mogućnost prilagođavanja širine



#### Možnost prilagajanja naklonskega kota

Angle adjustment option

Mogućnost prilagođavanja nagibnog kota

Mogućnost prilagođavanja nagiba



#### Možnost prilagajanja oblike

Shape adjustment option

Mogućnost prilagođavanja oblika

Mogućnost prilagođavanja oblika



#### Možnosti izbire barve profila

Stud colour options

Mogućnost odabira boje profila

Mogućnost izbora boje profila



**Za zelo zahtevne primere tuš kabin, ki jih ne najdete v tej ponudbi, lahko za kupca poiščemo individualno rešitev.**

When no suitable solution for complex shower cabins can be found in this catalogue, we'll be happy to fix an individual solution for you.

Za vrlo složene slučajeve tuš kabina koje niste pronašli u ovoj ponudi, za kupca možemo pronaći i individualno rješenje.

Za izuzetno komplikovane slučajeve tuš kabina, ako ih niste našli u ovoj ponudi, možemo za kupca potražiti individualno rešenje.



# 05

**Kopalniško pohištvo**  
Bathroom furniture  
Kupaonski namještaj  
Nameštaj za kupatilo

## Kopalniško pohištvo

Funkcionalnost, ergonomičnost in praktičnost so lastnosti, ki jih poleg svoje lepe in prefinjene oblike odražajo pohištva Kolpasan. Ponujajo nam raznolike rešitve za učinkovito izrabo prostora, preprosto čiščenje in organiziranje pripomočkov za kozmetiko in osebno higieno.

## Bathroom furniture

Functionality, ergonomics and practicality are the qualities reflected by the Kolpasan furniture in addition to its beautiful and sophisticated shape. It offers a variety of solutions for an efficient use of space, easy cleaning and organization of accessories for cosmetics and personal hygiene.

## Kupaonski namještaj

Funkcionalnost, ergonomija i praktičnost značajke su koje, pored svog lijepog i otmjenog oblika, odražavaju namještaj Kolpasan. Pruža nam razna rješenja za učinkovito korištenje prostora, jednostavno čišćenje i organiziranje pribora za kozmetiku i osobnu higijenu.

## Kupatilski nameštaj

Funkcionalnost, ergonomija i praktičnost su karakteristike koje pored sveg lepog i prefinjenog oblika odražavaju nameštaj Kolpasan. Nudi nam raznovrsna rešenja za efikasno korišćenje prostora, jednostavno čišćenje i organizovanje pribora za kozmetiku i ličnu higijenu.



\* **kopalniško pohištvo** | bathroom furniture | kupaonski namještaj | nameštaj za kupatilo

\*\* **umivalniki** | washbasins | umivaoniki | umivaoniki



\*

\*\*



# 05



## KOPALNIŠKO POHIŠTVO / BATHROOM FURNITURE KUPAONSKI NAMJEŠTAJ / KUPATILSKI NAMEŠTAJ



- **vsa pohištva iz programa Kolpasan ustrezajo evropskim standardom varnosti, kakovosti in trajnosti**
- all Kolpasan furniture complies with the European standards of safety, quality and durability
- sav namještaj iz programa Kolpasan zadovoljava Evropske norme sigurnosti, kvalitete i trajnosti
- sav nameštaj iz programa Kolpasan zadovoljava evropske standarde sigurnosti, kvaliteta i trajnosti



- **sodobno oblikovana linija 13 modelov pohištven čistih in elegantnih linij**
- a line of 13 models of furniture with clean and elegant lines and a modern design
- moderno dizajnirana linija od 13 modela namještaja čistih i elegantnih linija
- moderno dizajnirana linija od 13 modela nameštaja čistih i elegantnih linija



- **široka paleta dimenzij v modernih in klasičnih barvnih kombinacijah**
- a wide range of dimensions in modern and classic color combinations
- širok raspon dimenzija u modernim i klasičnim kombinacijama boja
- širok asortiman dimenzija u modernim i klasičnim kombinacijama boja



- **izdelke odlikujejo velike odlagalne površine in predali s polnim izvlekom**
- products are distinguished by large storage areas and full haul drawers
- proizvode karakteriziraju velike površine za odlaganje i ladice s punim izvlačenjem
- proizvode odlikuju velike površine za odlaganje i fioke sa punim izvlačenjem



- **uporaba vlago-odpornih lepil in robnih trakov**
- use of moisture-resistant adhesives and edge strips
- upotreba ljepila otpornih na vlagu i traka za rubove
- upotreba lepkova otpornih na vlagu i kant trake



- **izključna uporaba materialov evropskih proizvajalcev z ustreznimi EU certifikati**
- exclusive use of materials by European producers with the relevant EU certificates
- isključivo upotreba materijala evropskih proizvođača s odgovarajućim EU certifikatima
- isključiva upotreba materijala evropskih proizvođača sa odgovarajućim EU sertifikatima



- **uporaba kakovostnih okovij za tiho zapiranje**
- use of high-quality silent closing fittings
- upotreba kvalitetnih šarki za tiho zatvaranje
- upotreba kvalitetnih šarki za tiho zatvaranje





## Kopalniško pohištvo

Bathroom furniture  
Kupaonski namještaj  
Kupatilski nameštaj

106

**ORPHIA** 140, 120, 100, 80  
O/LG, V/GB, H/ACACIA LIGHT



**STORIA** 100, 90, 80, 60  
WH, ACACIA LIGHT



**ALEXIS** 150, 120, 100, 80, 60  
WH, GN, CW, DC

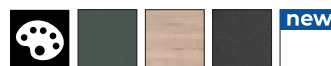

**VITTORIA** 120, 100, 80, 60  
WH, DG, BE



**JOY** 100, 80, 60  
CR, BO, LG



**MALAYA** 140, 100, 80  
DG, NO



**PANDORA** 150, 110, 75  
WH, NA, BL. STONE



**HARMONY F** 120, 100, 90, 70  
LG, CO, BO



**HARMONY W** 120, 100, 90, 70  
LG, CO, BO



### LED

- LED svetilka
- LED light
- LED svijetlo
- LED svetlo

### T

- Touch/senzorsko stikalo
- touch/sensor switch
- touch/senzorni prekidač
- touch/senzorski prekidač

### DIM

- regulator intenzivnosti svetlobe
- light dimmer
- regulator intenzivnosti svetla
- regulator intenzivnosti svetla

### C

- ura
- clock
- sat
- sat

### SW

- stikalo
- switch
- prekidač
- prekidač



## Kopalniško pohištvo

Bathroom furniture  
Kupaonski namještaj  
Kupatilski nameštaj

**NAOMI** 120, 100, 90, 80, 70, 60, 50  
WH, DC, NW



**OXANA** 105, 80, 60  
ACACIA LIGHT, WH



**EVELIN** 80, 65, 55  
WH, GRAY/ANT, GRAY/OAK

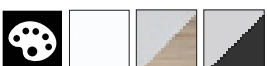

**EVELIN** 80 II, 65 II, 55 II  
WH, GRAY/ANT, GRAY/OAK

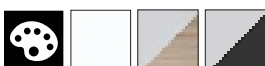

**EVELIN** 80 II/2, 65 II/2, 55 II/2  
WH, GRAY/ANT, GRAY/OAK

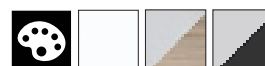

**KIKI** 60, 50, 40  
WH, CW



**BELLA** 80, 70, 60  
WH, CM



### S

- vtičnica
- socket
- utičnica
- utičnica

### IR

- senzorsko stikalo
- sensor switch
- senzorski prekidač
- senzorski prekidač

### CCT

- barva svetlobe na ogledalu nastavljiva od toplo bele do hladno bele (3000K - 6000K)
- color of light on the mirror adjustable from warm white to cold white (3000K - 6000K)
- boja svetla na ogledalu podesiva od tople bijele do hladno bijele (3000K - 6000K)
- boja svetla na ogledalu podesiva je od toplo bele do hladno bele (3000K - 6000K)



tiho zapiranje predala | silent-close drawers | tiho zatvaranje ladice | tiho zatvaranje fioke



detalj | detail | detajl | detajl



barva | colour | boja | boja

# ORPHIA 140, 120, 100, 80 LG, GB, ACACIA LIGHT

new

108





# STORIA 100, 90, 80, 60 WH, ACACIA LIGHT

new

110



# Storia 80

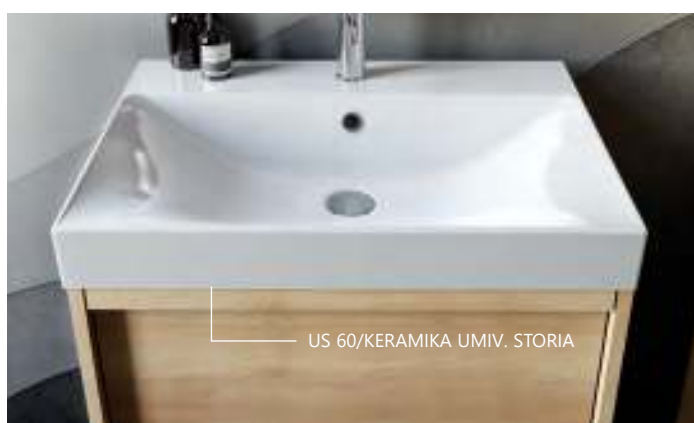

# ALEXIS 150, 120, 100, 80, 60 GN, CW, DC, WH

112



# Alexis 80



# VITTORIA 120, 100, 80, 60 WH, BE, DG

114





# JOY 100, 90, 60 LG, BO, CR

new

116



# Joy 80

117



# Joy 60



# MALAYA 140, 100, 80 DG, NO

118





# Malaya 100

# Malaya 80

# PANDORA 150, 110, 75 WH, NA, BL. STONE

120





# HARMONY 120, 100, 90, 70 LG, CO, BO

122





# Harmony 100

H 702/600 LG

OG ORBIS 100 - LED, IR

H 562/600 LG

OUHW 100 LG



# Harmony 70

OG QUADRUM 70 - LED, IR

OUHW 70 BO

H 1601/450 BO

# NAOMI 120, 100, 90, 80, 70, 60, 50 WH, NW, DC

124







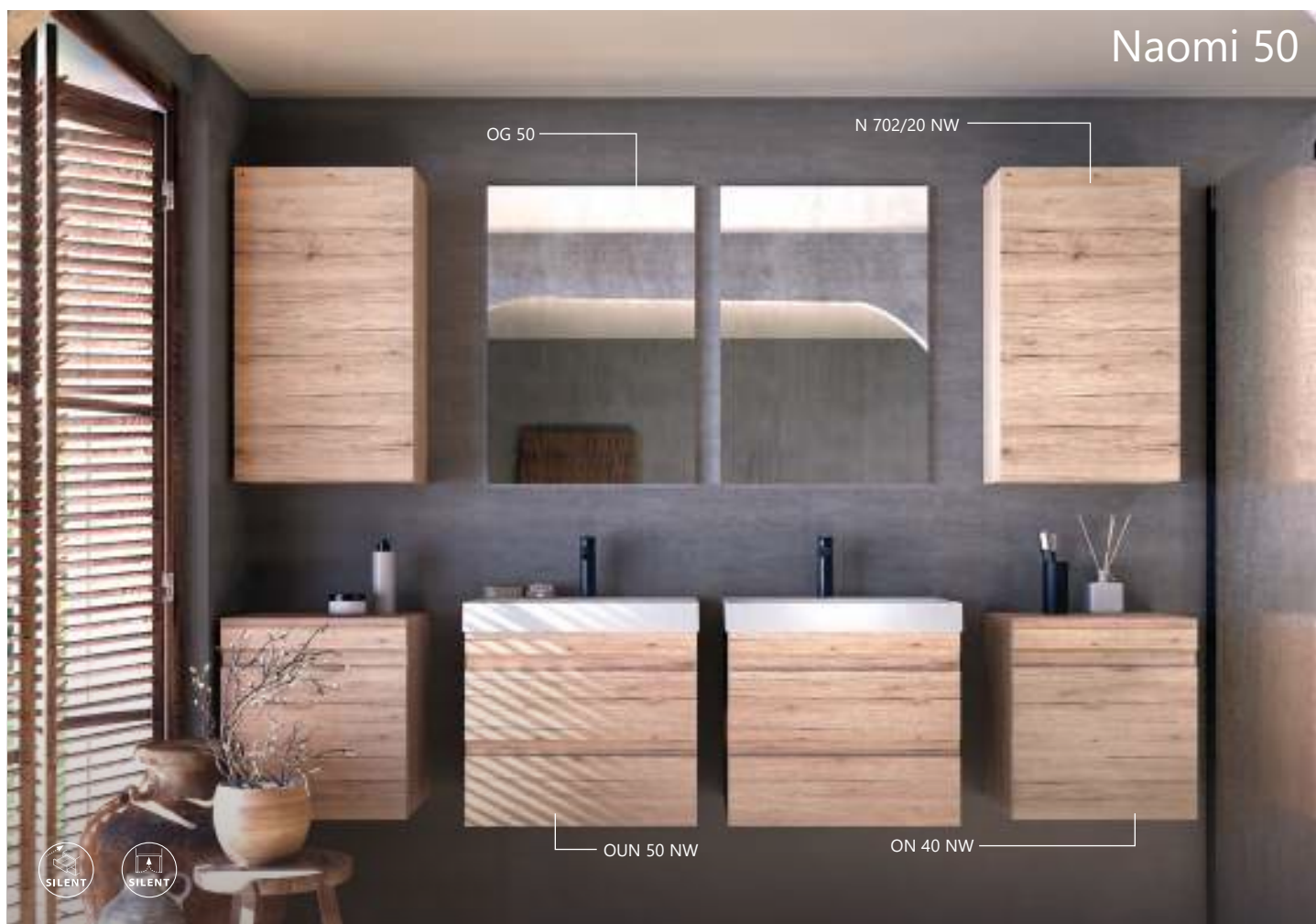

# OXANA 105, 80, 60 WH, ACACIA LIGHT



O 1752 WH

OG 100 - LED, T, DIM, CCT

O 953 WH

O 105 WH

## Oxana 105

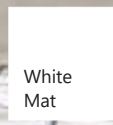

TOO - LED, SW, S



UNO-BLACK

UNO-CHR





# KIKI 60, 50, 40 WH, CW



OGK 40/90 WH

OUK 60 WH

Kiki 60 WH

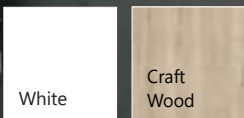

White

Craft Wood



OUK 60 -L WH

Kiki 60 - L,D WH



LUČ 300 - LED



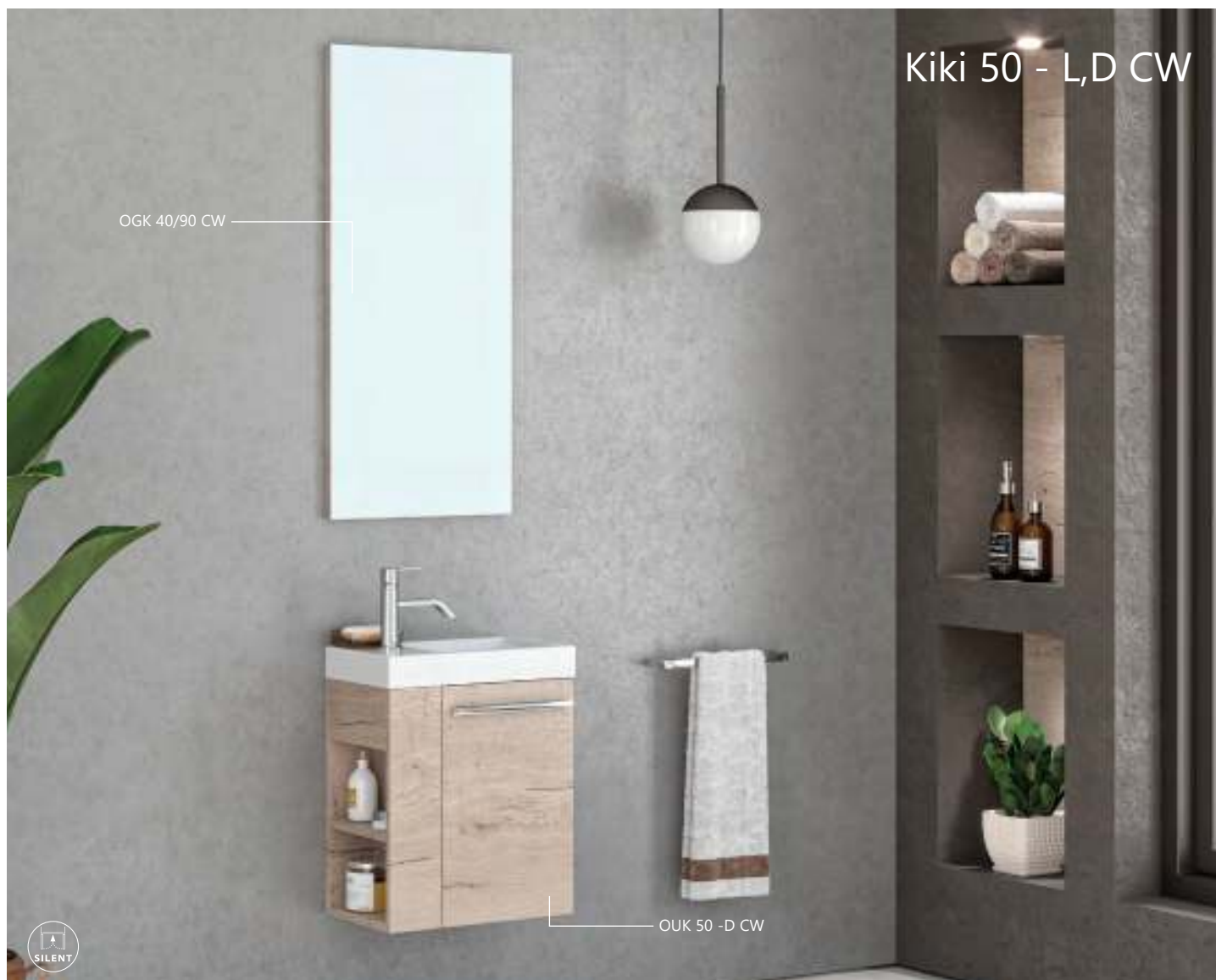

# EVELIN

80, 80 II, 80 II/2  
 65, 65 II, 65 II/2  
 55, 55 II, 55 II/2

WH/WH, GRAY/OAK, GRAY/ANTRACIT

132



# Evelin 65 II



# Evelin 65



# BELLA 80, 70, 60 WH, CM

134



# Bella 60

135





# 06

**Kopalniški dodatki**  
Bathroom accessories  
Kupaonski dodaci  
Kupatilski dodaci

## Majhni detajli, ki nas odražajo

Kako dodatno izboljšati in narediti našo kopalnico edinstveno? Tako, da jo z okusom in dovršeno, a lično funkcionalnostjo opremimo s kopalniškimi dodatki Kolpasan, ki odgovarjajo na naše potrebe po varnosti, estetiki in udobju.

## Small details that reflect us

How to further improve and make our bathroom unique? By furnishing it with tasteful and sophisticated but elegant functionality of Kolpasan bathroom accessories that meet our needs for safety, aesthetics and comfort.

## Maleni detajli koji nas čine posebnim

Kako dodatno unaprijediti i učiniti našu kupaonice jedinstvenom. Tako što ćemo je opremiti sa stilom i sofisticiranom, ali elegantnom funkcionalnošću pribora za kupaonice Kolpasan koji zadovoljava naše potrebe za sigurnošću, estetikom i udobnošću.

## Maleni detajli koji nas čine posebnim

Kako dodatno da unapredimo i učinimo naše kupatilo jedinstvenim? Tako što ćemo ga opremiti sa stilom i sofisticirano, ali i elegantnom funkcionalnošću pribora za kupatila Kolpasan, koji zadovoljava naše potrebe za sigurnošću, estetikom i udobnošću.





## Pohišteneni nosilec za brisače

Cabinet towel holder

Namještajni držač za ručnike

Nameštajni držač za peškiri

138

Dopolnite svojo kopalnico s pohištenim nosilcem za brisače, oblikovanim v duhu Kolpasanove filozofije: brezčasna eleganca, premišljena funkcionalnost in vrhunska kakovost. Minimalističen dizajn se popolnoma ujema z estetskimi smernicami Kolpasanovih kopalniških programov. Brisače bodo vedno na doseg roke, prostor pa bo ostal urejen in vizualno čist.

Enhance your bathroom with a furniture towel holder designed in the spirit of Kolpasan's philosophy: timeless elegance, thoughtful functionality, and superior quality. Its minimalist design perfectly aligns with the aesthetic guidelines of Kolpasan's bathroom collections. Your towels will always be within easy reach, while the space remains tidy and visually clean.

Upotpunite svojo kupaonico namještajem – držačem za ručnike, oblikovanim u duhu Kolpasanove filozofije: bezvremenska elegancija, promišljena funkcionalnost i vrhunska kvaliteta. Minimalistički dizajn savršeno se uklapa u estetske smjernice Kolpasanovih kupaonskih programa. Ručnici će vam uvijek biti pri ruci, a prostor će ostati uredan i vizualno čist.

Upotpunite svoje kupatilo nameštajem – držačem za peškire, oblikovanim u duhu Kolpasanove filozofije: bezvremenska elegancija, promišljena funkcionalnost i vrhunski kvalitet. Minimalistički dizajn savršeno se uklapa u estetske smernice Kolpasanovih kupatilskih programa. Peškiri će vam uvek biti na dohvat ruke, a prostor će ostati uredan i vizuelno čist.



### Pohišteneni nosilec za brisače

Cabinet towel holder

Namještajni držač za ručnike

Nameštajni držač za peškire

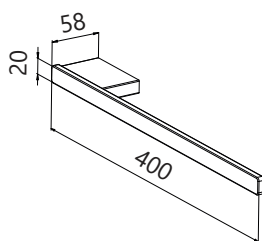





## Kopalniški dodatki

Bathroom accessories

Kupaonski dodaci

Kupaonski dodaci

V naši ponudbi kopalniških dodatkov je sedaj na voljo kar 66 novih izdelkov. Vsak od njih je kakovostno izdelan in prinaša dodatno funkcionalnost v vašo kopalnico. Med širokim izborom kopalniške galanterije lahko izbirate med družinami EOS, KRIOS in REA v kromirani in črni mat izvedbi.

There are now 66 new products in our bathroom accessories range. Each one is quality made and brings extra functionality to your bathroom. Choose from a wide range of bathroom fittings in the EOS, KRIOS and REA families in chrome and matt black.

U našoj ponudi kupaonskih dodataka sada je 66 novih proizvoda. Svaki od njih kvalitetno je izrađen i donosi dodatnu funkcionalnost u Vašu kupaonicu. Možete izabrati između širokog izbora kupaonske galanterije obitelji EOS, KRIOS i REA un kromiranom i crnom mat dizajnu.

Naš asortiman opreme za kupatilo sada obuhvata čak 66 novih proizvoda. Svaki od njih napravljen je od najkvalitetnijih materijala, modernog dizajna i unosi dodatnu funkcionalnost u Vaše kupatilo. Među širokim izborom opreme za kupatilo, možete birati između galanterije EOS, KRIOS i REA koje Vam nudimo u hromiranim i crnim mat verzijama.

Eos

EO-01

Chrome



20 x 55 x 46

Eos

EO-02

Chrome



69 x 105 x 97

Eos

EO-03

Chrome



100 x 35 x 112

Eos

EO-04

Chrome



194 x 20 x 109

Eos

EO-05

Chrome



450 x 20 x 64

Eos

EO-06

Chrome



595 x 20 x 64

Eos

EO-07

Chrome



595 x 20 x 120

Eos

EO-08

Chrome



170 x 20 x 64

Eos

EO-09

Chrome



150 x 104 x 58

Eos

EO-10

Chrome



92 x 372 x 119

**Krios** KR-01  
KR-01B

Chrome  
Black



38 x 38 x 50

**Krios** KR-02  
KR-02B

Chrome  
Black



69 x 105 x 104

**Krios** KR-03  
KR-03B

Chrome  
Black



99 x 43 x 119

**Krios** KR-04  
KR-04B

Chrome  
Black



456 x 38 x 70

**Krios** KR-05  
KR-05B

Chrome  
Black



601 x 38 x 70

**Krios** KR-06  
KR-06B

Chrome  
Black



601 x 38 x 116

**Krios** KR-07  
KR-07B

Chrome  
Black



158 x 38 x 70

**Krios** KR-08  
KR-08B

Chrome  
Black



137 x 120 x 50

**Krios** KR-09  
KR-09B

Chrome  
Black



92 x 370 x 126



Rea RE-01  
RE-01B

Chrome  
Black



52 x 52 x 70

Rea RE-02  
RE-02B

Chrome  
Black



67 x 99 x 106

Rea RE-03  
RE-03B

Chrome  
Black



110 x 55 x 127

Rea RE-04  
RE-04B

Chrome  
Black

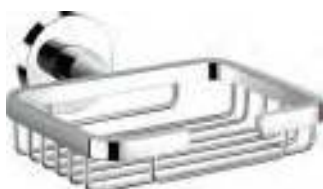

126 x 52 x 141

Rea RE-05  
RE-05B

Chrome  
Black



463 x 52 x 70

Rea RE-06  
RE-06B

Chrome  
Black



613 x 52 x 70

Rea RE-07  
RE-07B

Chrome  
Black



613 x 52 x 118

Rea RE-08  
RE-08B

Chrome  
Black



156 x 52 x 91

Rea RE-09  
RE-09B

Chrome  
Black



137 x 159 x 63

Rea RE-10  
RE-10B

Chrome  
Black



115 x 370 x 144

EI EL-01

Chrome



363 x 174 x 42

EI EL-02

Chrome



138 x 30 x 28

EI EL-03

Chrome



198 x 30 x 28

EI

EL-04

Chrome



258 x 30 x 28

EI

EL-05

Chrome



318 x 30 x 28

EI

EL-06

Chrome



378 x 30 x 30

EI

EL-07

Chrome



613 x 150 x 228

EI

EL-08

Chrome



615 x 190 x 259

EI

EL-09

Chrome



300 x 700 x 223

EI

EL-10

Chrome



202 x 383 x 202

EI

EL-11

Chrome



300 x 82 x 145

EI

EL-12

Chrome



210 x 76 x 210

EI

EL-13



400 x 80 x 50

EI

EL-14

Chrome



403 x 215 x 87

EI

EL-15

Chrome



82 x 386

EI

EL-16

Chrome



248 x 38 x 152

EI

EL-17  
EL-17B

Chrome

Black



40 x 25 x 43



**Wall Box Nexa**  
The Wall Box Nexa  
Wall Box Nexa  
Wall Box Nexa

Wall Box Nexa se vgradi v steno in ustvari podobo police, ki zagotavlja veliko prostora za shranjevanje šamponov in potrebščin, tako da jih imate pri roki med tuširanjem. Z moderno zasnovano iz nerjavečega jekla se brezhibno prilega večini sodobnih kopalniških stilov in prihrani prostor.

The Wall Box Nexa is built into the wall and creates the appearance of a shelf, providing plenty of storage space for shampoos and essentials, so you have them at hand while showering. With a modern stainless steel design, it fits seamlessly into most modern bathroom styles and saves space.

Wall Box Nexa ugrađena je u zid i stvara izgled police, pružajući puno prostora za pohranu šampona i osnovnih potrepština, tako da ih imate pri ruci tijekom tuširanja. S modernim dizajnom od nehrđajućeg čelika, besprijekorno se uklapa u većinu modernih stilova kupaonica i štedi prostor.

Wall Box Nexa je ugrađena u zid i stvara izgled police, pružajući puno prostora za odlaganje šampona i toaletnih potrepština, tako da ih imate pri ruci dok se tuširate. Sa modernim dizajnom od nerđajućeg čelika, besprekorno se uklapa u većinu modernih stilova kupatila i štedi prostor.

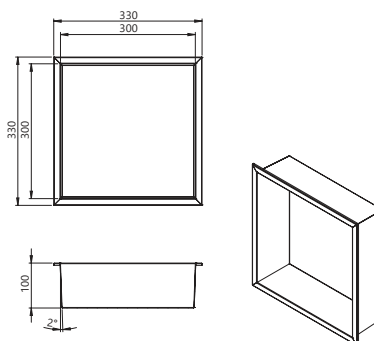
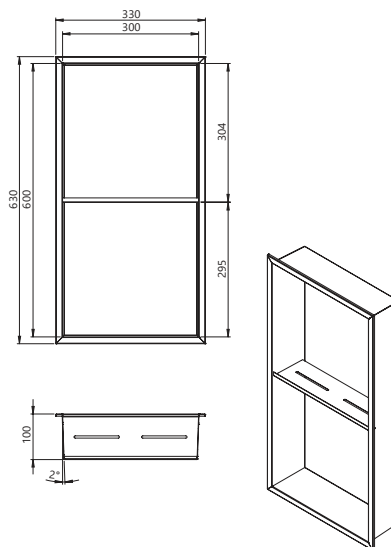





## Vzglavniki

Headrests

Nasloni za glavu

Nasloni za glavu



Headrest soft

Vzglavnik za kopalne kad: Lenox SP, Evita, Betty,  
Headrest for bathtubs: Dolores, Libretto, Gaia,  
Nasloni za glavu za kupaonske kade: Divante, Beatrice,  
Calando, Nabucco,  
Nasloni za glavu za kade: Elektra SP, Samson,  
Tamia, Dream SP



Headrest coast

Vzglavnik za vse modele kopalnih kadi.  
Headrest for all models of bathtubs.  
Naslon za glavu za sve modele kupaonskih kada.  
Naslon za glavu za sve kade.



## Armature za kopalne kadi

Bathtub fittings

Armature za kadu

Armatura za kadu



Stream CHR



Stream Black



Waterfall



Raindrop



Geyser

1. Enoročna armatura s tuš ročico za kopalne kadi z oblogo.
1. Single-lever bath mixer with hand shower for bathtubs with a panel.
1. Jednoročna miješalica s tuš ručicom za kupaonske kade s oblogom.
1. Jednoročna baterija sa tuš ručkom za kade sa oblogom.

2. Enoročna armatura s tuš ročico in polnilno / odlivno prelivno garnituro za polnjenje kadi (za kopalne kadi z oblogo).
2. Single-lever bath mixer with hand shower and filler / overflow set for filling bathtubs (for bathtubs with a panel).
2. Jednoročna miješalica s tuš ručicom i priljev / odljev prelivnom garnituroom za punjenje kada (za kupaonske kade s oblogom).
2. Jednoročna armatura s tuš ručicom i preliv / odliv prelivnom garnituroom za punjenje kada (za kade sa oblogom).



## Kopalniški stolček iz Kerrocka

Bathroom chair made of Kerrock

Kupaonska stolica od Kerrocka

Sedište za kupatilo od Kerrocka

147

**KS-K kopalniški stolček iz Kerrocka, prenosni (nosilnost 160 kg) / KS-K bathroom chair from Kerrock, mobile (load capacity 160 kg)**

KS-K kupaonska stolica od Kerrocka, mobilan (nosivost 160 kg) / KS-K sedište za kupatilo od Kerrocka, mobilni (nosivost 160 kg)



KS-K

new



380 x 300 x 430



700 x 350 x 430



430 x 370 x 510





**Kopalniški sedeži**  
Bathroom seats  
Kupaonska sijedala  
Sedišta za kupatilo





### Dodatki za kopalne kadi

Bathtub accessories

Dodaci kupaonskim kadama

Dodaci za kade



### Zaključna letvica za kopalne in tuš kadi

Bath and shower tray trim strip

Završna letvica za kupaonske kade i tuš kade

Završna lajsna za kade i tuš kade



PAL 650, 450, KROM

### Prelivna garnitura s sifonom

Overflow set with a siphon

Preljevna garnitura sa sifonom

Prelivna garnitura sa sifonom



WHITE  
UP & DOWN

### Prelivna garnitura s sifonom

Overflow set with a siphon

Preljevna garnitura sa sifonom

Prelivna garnitura sa sifonom



### Servisno prezračevalni pokrov z rešetko (45 x 45)

Service-ventilation cover with a grate (45 x 45)

Servisno ventilacijski pokrov s rešetkom (45 x 45)

Servisno ventilacioni pokrov sa rešetkom (45 x 45)



### Dodatki za tuš kadi

Accessories for shower trays

Dodaci za tuš kade

Dodaci za tuš kade

Ø	h	POKROV SIFONA / SIPHON COVER POKROV SIFONA / POKLOPAC SIFONA	
Ø 90	84	•	
	65	•	
Ø 52	65	•	

### Sifon za tuš kadi / Siphon for shower trays

Sifon za tuš kade / Sifon za tuš kade



## Podnožja kopalnih kadi

Bathtub support frames  
Podnožje kade za kupanje  
Postolja za kade

### Podnožje klasičnih kopalnih kadi za ugradnjo / Base feet for the built-in bathtub

Podnožje klasičnih kade za kupanje za ugradnjo / Postolja klasičnih kade za kupanje za ugradnjo

#### 501 PKK

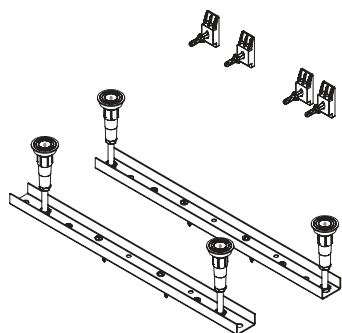

#### 800 PKK

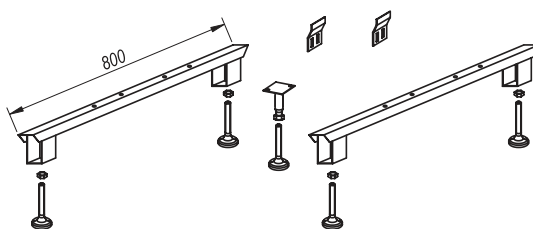

Adam & Eva, Nabucco, Elektra, Samson

#### 1001 L

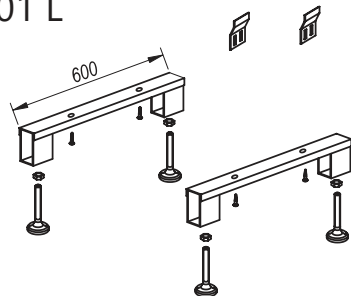

Royal, Beatrice, Divante

#### 1001 B

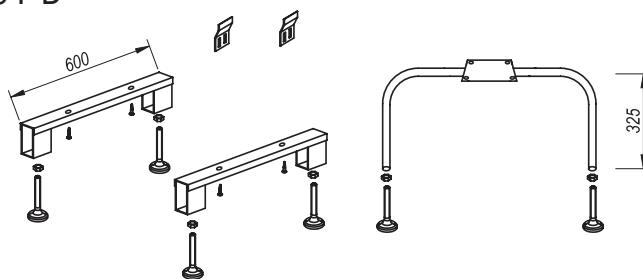

Dolores

### Podnožje za obloge / Support frame for the bathtub with panel / Podnožje za obloge / Postolje za obloge

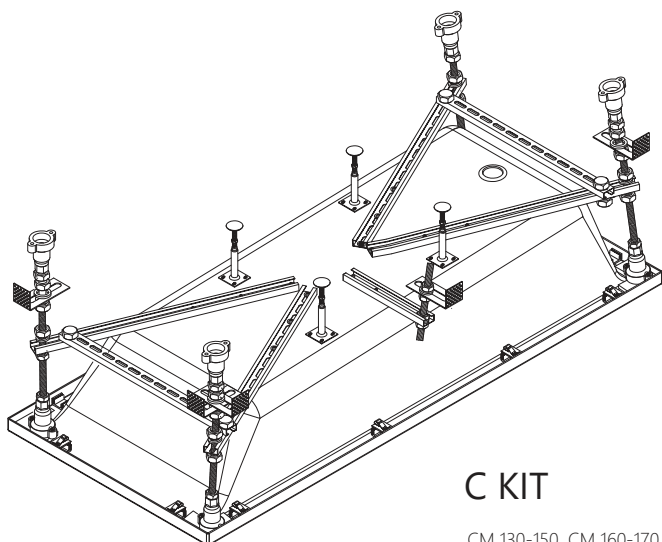

#### C KIT

CM 130-150, CM 160-170, CM 180-200, CAM 150-180, CKM 120-150, CME 170-190, CD 140



## Čistila, razkužila, premazi

Cleaning agents, disinfectants, protective paints  
Sredstva za čiščenje, dezinfekcijska sredstva, premazi  
Sredstva za čiščenje, sredstva za dezinfekcijo, premazi



### Kolpasan, Specialno čistilo zelo učinkovito odstranjuje vodni kamen na kopalnih in tuš kadeh ter stekel tuš kabin.

Kolpasan, Special cleaning agent removes calcium buildup in baths and showers and shower cabins very effectively.

Kolpasan, Specijalno sredstvo za čiščenje učinkovito uklanja kamenac na kupaonskim i tuš kadama te staklima tuš kabina.

Kolpasan, Specijalno sredstvo za čiščenje vrlo efikasno uklanja naslage kamenca na kadama, tuš kadama i staklenim površinama.



### Eco san, Specialno čistilo zelo učinkovito odstranjuje vodni kamen na kopalnih in tuš kadeh ter stekel tuš kabin.

Eco san, Special cleaning agent removes calcium buildup in baths and showers and shower cabins very effectively.

Eco san, Specijalno sredstvo za čiščenje učinkovito uklanja kamenac na kupaonskim i tuš kadama te staklima tuš kabina.

Eco san, Specijalno sredstvo za čiščenje vrlo efikasno uklanja naslage kamenca na kadama, tuš kadama i staklenim površinama.



### Keril, Specialno kremno abrazivno čistilo za Kerrock

Keril, Special creamy abrasive cleaner for Kerrock

Keril, Specijalno kremasto abrazivno sredstvo za čiščenje za Kerrock

Keril, Specijalno kremasto abrazivno sredstvo za čiščenje za Kerrock



### Čistilo za popolno higijeno masažnih kadi

Cleaning agent for perfect hygiene of your massage tub

Sredstvo za čiščenje za savršenu higijenu masažnih kada

Sredstvo za čiščenje za potpunu higijenu masažnih kada



### Kolpasan, mast za ležaje in tečaje tuš kabin

Kolpasan, bearing and hinges grease for shower enclosures

Kolpasan, mast za ležajeve i tečajeve tuš kabina

Kolpasan, mast za ležajeve i šarke tuš kabina

Bolje za okolje...  
Better for the environment...

Bolje za okoliš...

**Bolje za životnu sredinu...**

- zmanjšan vpliv na vodne organizme
- zmanjšana količina nevarnih snovi
- zmanjšana količina odpadne embalaže

- less impact on aquatic organisms
- less hazardous substances
- less packaging waste



- smanjen utjecaj na vodene organizme
- smanjena količina opasnih tvari
- smanjena količina otpadne ambalaže

- smanjen utjecaj na vodene organizme
- smanjena količina opasnih materija
- smanjena količina otpadne ambalaže

**...bolje za vas.**

**...better for you.**

**...bolje za vas.**

**...bolje za vas.**



## Toaletne omarice in ogledala

Bathroom cabinets and mirrors

Toaletni ormarići i ogledala

Toaletni ormarići i ogledala

152

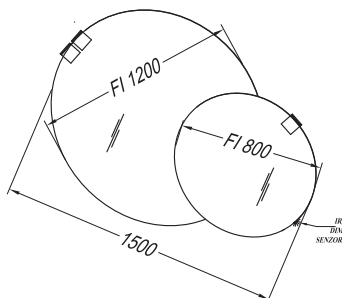

OG Ø150 - LED, IR, DIM

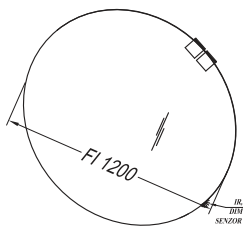

OG Ø120 - LED, IR, DIM

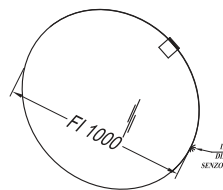

OG Ø100 - LED, IR, DIM

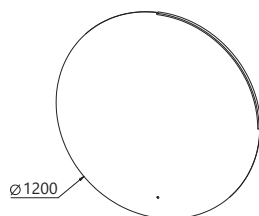

OG ORBIS Ø120 - LED, IR

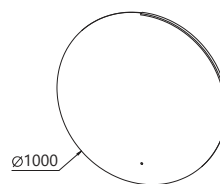

OG ORBIS Ø100 - LED, IR

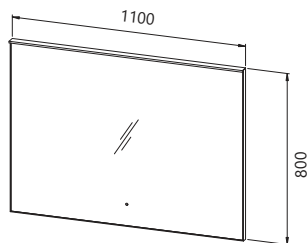

OG QUADRUM 110 - LED, IR

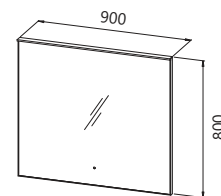

OG QUADRUM 90 - LED, IR

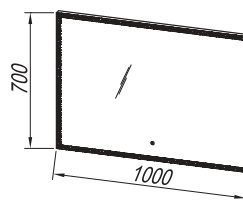

OG 100 - LED, T, DIM, CCT

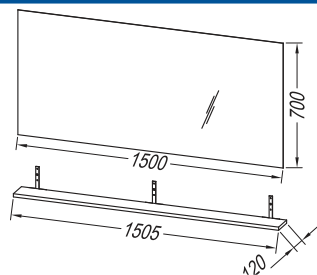

OG 150 / POL OG 150

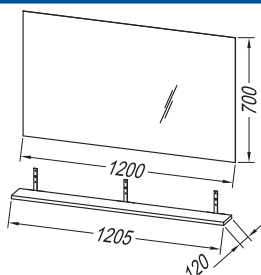

OG 120 / POL OG 120

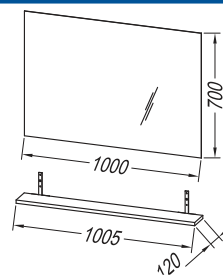

OG 100 / POL OG 100

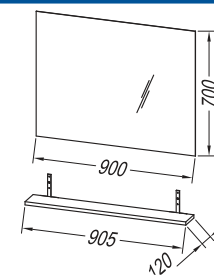

OG 90 / POL OG 90



**Toaletne omarice in ogledala**

Bathroom cabinets and mirrors

Toaletni ormarići i ogledala

Toaletni ormarići i ogledala

G

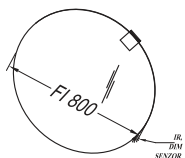

OG Ø80 - LED, IR, DIM

E

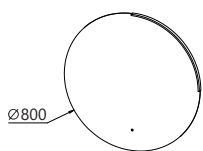

OG ORBIS Ø80 - LED, IR

E

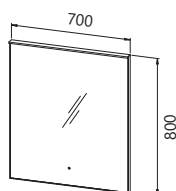

OG QUADRUM 70 - LED, IR

F

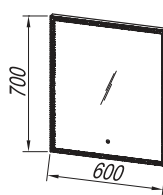
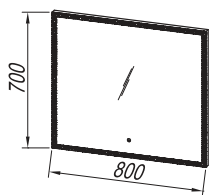

OG 80 - LED, T, DIM, CCT

OG 60 - LED, T, DIM, CCT

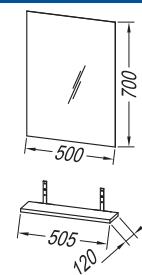
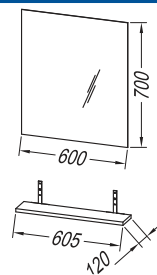
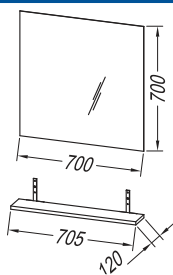
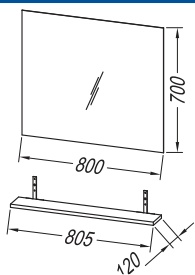

OG 80 / POL OG 80

OG 70 / POL OG 70

OG 60 / POL OG 60

OG 50 / POL OG 50

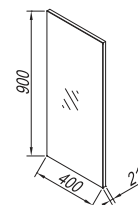
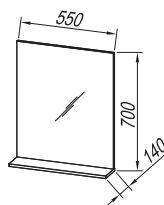
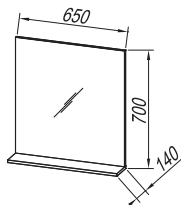
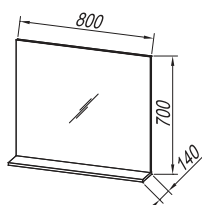

OGE 80

OGE 65

OGE 55

OGK 40/90



## Toaletne omarice in ogledala

Bathroom cabinets and mirrors

Toaletni ormarići i ogledala

Toaletni ormarići i ogledala

154

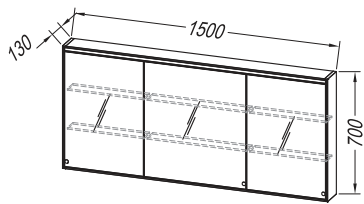

TO 150 BL - LED, SW, S

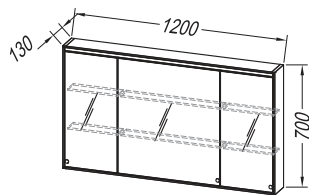

TO 120 BL - LED, SW, S

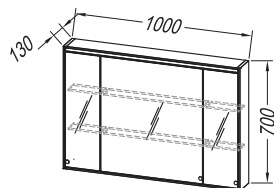

TO 100 BL - LED, SW, S

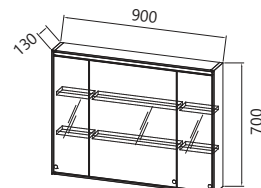

TO 90 BL - LED, SW, S

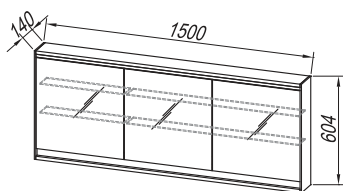

TOP 150 - LED, SW, S

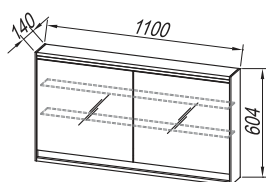

TOP 110 - LED, SW, S

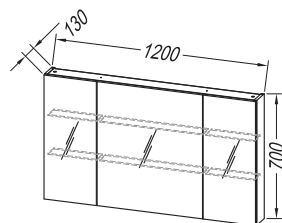

TON 120

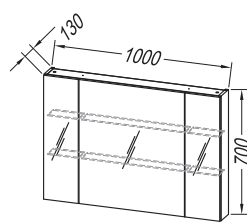

TON 100

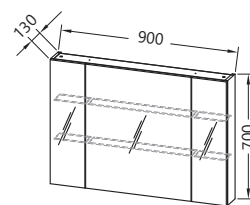

TON 90

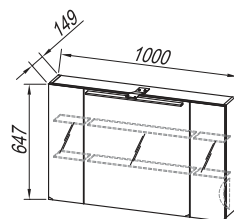

TOO 100 -LED, SW, S





## Toaletne omarice in ogledala

Bathroom cabinets and mirrors

Toaletni ormariči i ogledala

Toaletni ormariči i ogledala

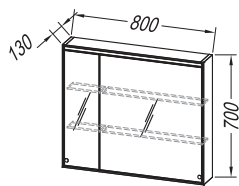

TO 80 BL - LED, SW, S

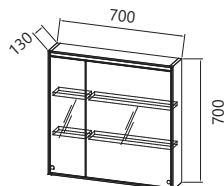

TO 70 BL - LED, SW, S

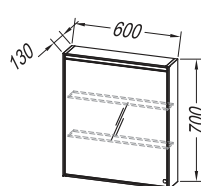

TO 60 BL - LED, SW, S

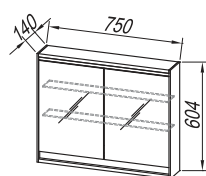

TOP 75 - LED, SW, S

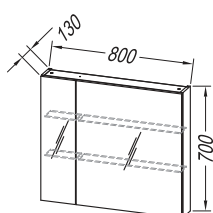

TON 80

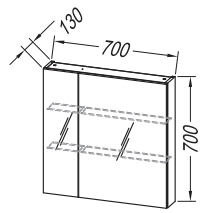

TON 70

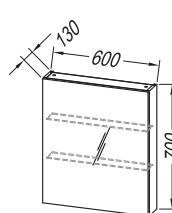

TON 60

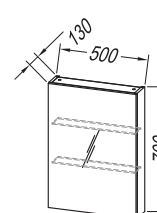

TON 50

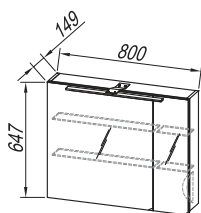

TOO 80 -LED, SW, S

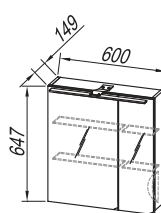

TOO 60 -LED, SW, S

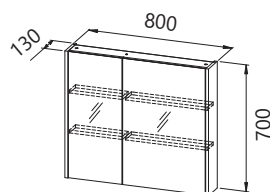

TOB 80

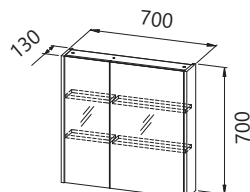

TOB 70

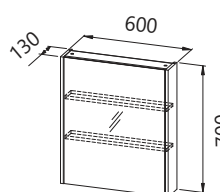

TOB 60

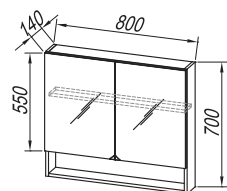

TOE 80

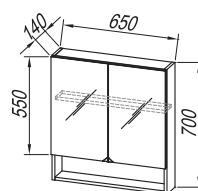

TOE 65

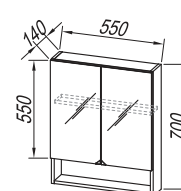

TOE 55



## Dodatne luči za kopalniško pohištvo

Additional lights for bathroom furniture  
 Dodatne svjetiljke za kupaonski namještaj  
 Dodatne lampe za nameštaj za kupatilo

156



F

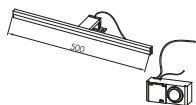

LUČ 500 BOX -LED, SW, S



E

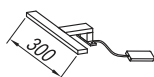

LUČ 300 -LED



C



LUČ 500 BL -LED, CCT



C

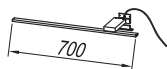

LUČ 700 BL -LED, CCT



C



LUČ 500 BL BOX -LED, SW, S, CCT



C

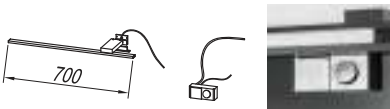

LUČ 700 BL BOX LED, SW, S, CCT

## Tehnični podatki svetil / Technical data of light fixtures

Tehnički podaci svjetiljki / Tehnički podaci o lampama

Zap. št. S. Nr. Red. Br. Red. Br.	Izdelek Product Proizvod Proizvod	Tip sijalke Bulb Type Tip žarulje Tip sijalice
1	OG Ø80 - LED, IR, DIM	LED
	OG Ø100 - LED, IR, DIM	LED
	OG Ø120 - LED, IR, DIM	LED
	OG Ø150 - LED, IR, DIM	LED
2	TOP 75 - LED, SW, S	LED
	TOP 110 - LED, SW, S	LED
	TOP 150 - LED, SW, S	LED
3	TO 60 BL -LED, SW, S	LED
	TO 70 BL -LED, SW, S	LED
	TO 80 BL -LED, SW, S	LED
	TO 90 BL - LED, SW, S	LED
	TO 100 BL -LED, SW, S	LED
	TO 120 BL -LED, SW, S	LED
	TO 150 BL -LED, SW, S	LED
4	OG 60 - LED, T, DIM, CCT	LED
	OG 80 - LED, T, DIM, CCT	LED
	OG 100 - LED, T, DIM, CCT	LED
5	TOO 60 - LED, SW, S	LED
	TOO 80 - LED, SW, S	LED
	TOO 100 - LED, SW, S	LED
6	LUČ / LIGHT / SVIJETLO / OSVETLJENJE 500 - LED, SW, S	LED
7	LUČ / LIGHT / SVIJETLO / OSVETLJENJE 300 - LED	LED
8	LUČ / LIGHT / SVIJETLO / OSVETLJENJE 500 BL LED, CCT	LED
9	LUČ / LIGHT / SVIJETLO / OSVETLJENJE 700 BL LED, CCT	LED
10	LUČ / LIGHT / SVIJETLO / OSVETLJENJE 500 BL box-LED, SW, S, CCT	LED
11	LUČ / LIGHT / SVIJETLO / OSVETLJENJE 700 BL box-LED, SW, S, CCT	LED
12	OG QUADNUM 700X800 LED, IR	LED
	OG QUADNUM 900X800 LED, IR	LED
	OG QUADNUM 1100X800 LED, IR	LED
	OG ORBIS F1800 LED, IR	LED
	OG ORBIS F11000 LED, IR	LED
	OG ORBIS F11200 LED, IR	LED

**Tehnični podatki svetil /** Technical data of light fixtures

Tehnički podaci svjetiljki / Tehnički podaci o lampama

Energijski razred Energy class Energijski razred Energetska klasa	Ponderirana moč (kWh/1000h) Weighted power (kWh/1000h) Ponderirana snaga (kWh/1000h) Ponderisana snaga (kWh/1000h)	Lumen (lm)	Kelvin (K)	Identifikacijska oznaka Identification code Identifikacijska oznaka Identifikaciona oznaka	IP luči IP of the light IP svjetla IP svetiljke
G	4,8	240	3800	LED - 3	44
G	4,8	240	3800		44
G	9,6	480	3800		44
G	14,4	720	3800		44
F	6,7	626www	4000-4500	LED - 3	21
F	10,1	928	4000-4500		21
F	14	1274	4000-4500		21
F	5	475	4000-4500		21
F	6	639	4000-4500		21
F	7	648	4000-4500		21
F	8	835	4000-4500		21
F	9	820	4000-4500		21
F	11	1131	4000-4500		21
F	14	1426	4000-4500		21
F	17	2200	2700-6500		LED - 3
F	18	2200	2700-6500	44	
F	21	2200	2700-6500	44	
G	6,5	747	4000-4500	LED - 3	21
G	6,5	747	4000-4500		21
G	6,5	747	4000-4500		21
F	8,5	944	4000	LED - 3	44
E	4,5	180	4000	LED - 3	44
C	7,2	800	3000-4000	LED - 3	44
C	7,2	1120	3000-4000	LED - 3	44
C	7,2	800	3000-4000	LED - 3	44
C	7,2	1120	3000-4000	LED - 3	44
E	25	750	4000	LED - 3	44
E	29,4	750	4000		44
E	33,6	750	4000		44
E	21,7	750	4000		44
E	27,2	750	4000		44
E	31	750	4000		44



[kolpasan.si](https://kolpasan.si)



[kolpasanbykolpa](https://kolpasanbykolpa)



[kolpasan\\_by\\_kolpa](https://kolpasan_by_kolpa)





## **Oblikovano za ugodje.**

Designed to indulge | Dizajnirano za udobnost | Dizajnirano za udobnost